

PLANE

PLN-U

UNLIT - SUSPENDED

DATE	PROJECT	CATALOG #	FIXTURE TYPE
------	---------	-----------	--------------

OVERVIEW

PLANE is a modular building block. Offered in customizable dimensions and a myriad of surface styles, it can be applied on the wall or ceiling by traditional hardware, snap-on hardware, or adhesive. Flexible for designers and easy for contractors, PLANE is ideal for acoustic intervention in spaces that require a creative solution.

QUICK FACTS

- Available in any Surface Style
- Custom lengths between 35 - 89 IN and widths between 12 - 41 IN
- Custom suspension available between 24 - 120 IN
- Mount to the wall or ceiling with regular hardware, snap-on hardware, or adhesive
- NRC rating of .95+

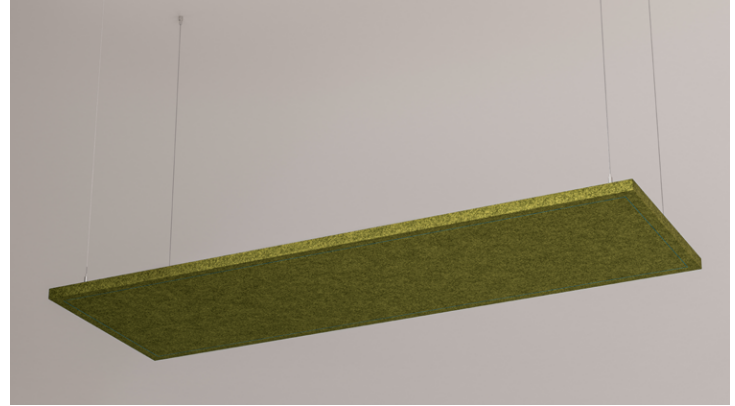

SPECIFICATIONS

SERIES	SURFACE STYLE	SURFACE STYLE - DIRECTION	LENGTH ¹	WIDTH ¹	FELT COLOR (9 MM)
PLN-U	SNO NO SURFACE STYLE FFL FINE FLUTE MFL MID FLUTE WFL WIDE FLUTE	NA NOT APPLICABLE SDL PARALLEL TO LENGTH SDW PARALLEL TO WIDTH	35" (900 MM) 47" (1200 MM) 59" (1500 MM) 71" (1800 MM) 83" (2100 MM) CL__ ²	12" (300 MM) 24" (600 MM) 35" (900 MM) 39" (1000 MM) CW__ ³	9__ REPLACE "__" WITH DESIRED COLOR CODE FROM SWATCHES
SUSPENSION TYPE		CEILING TYPE	CANOPY ⁶	FACTORY OPTIONS ⁷	
AC__ 60" AIRCRAFT CABLE + (COLOR CODE) ⁴ ST__ 60" STRAP + (COLOR CODE) ⁴ TRD 3/8" THREADED ROD DT DIRECT TO	HC HARD CEILING ⁵ ST STRUT SG STANDARD GRID TG TEGULAR GRID	NC NO CANOPIES RWH ROUND WHITE RBK ROUND BLACK SWH SQUARE WHITE SBK SQUARE BLACK	CSL__ CUSTOM SUSPENSION LENGTH 24" - 120" ⁸ CT__ CUSTOM THREAD + (COLOR CODE) ⁴ BABA BABA REQUIRED		

¹ IMPERIAL DIMENSIONS ARE NOMINAL. ACTUAL DIMENSIONS ARE METRIC.
² CUSTOM LENGTHS AVAILABLE BETWEEN 35" - 89" (900 - 2250 MM).
³ CUSTOM WIDTHS AVAILABLE BETWEEN 12" - 41" (300 - 1050 MM).
⁴ REPLACE "__" WITH DESIRED COLOR CODE FROM SWATCHES.

⁵ NOT AVAILABLE IN DIRECT TO SUSPENSION TYPE
⁶ OPTIONAL 2IN CANOPIES CAN BE INCLUDED FOR CABLE, STRAP, OR GRID SUSPENSION.
⁷ LEAVE BLANK IF NOT APPLICABLE. STRING TOGETHER MULTIPLE SELECTIONS.
⁸ REPLACE "__" WITH LENGTH OF DESIRED SUSPENSION.

EXAMPLE CATALOG #: PLN-U-SNO-NA-47(1200)-24(600)-9JD-ACBLK-HC-NC

SABIN

© 2025 SABIN LLC. ALL RIGHTS RESERVED.
 CUSTOMIZE AT SABIN.BUILD
 DATE REVISED 09.23.2025



1

COLOR SWATCHES

PLN-U

DATE	PROJECT	CATALOG #	FIXTURE TYPE
------	---------	-----------	--------------

FELT

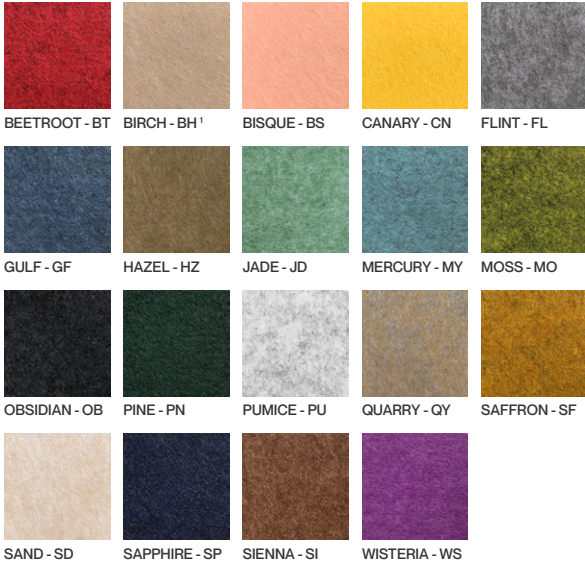

SUSPENSION STRAP

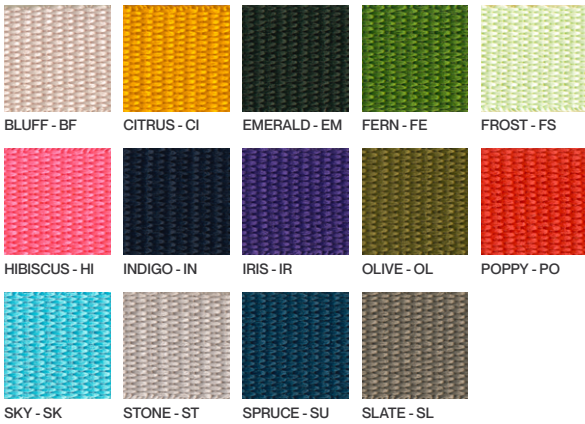

AIRCRAFT CABLE

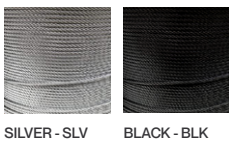

THREAD



Colors are subject to slight variation from your screen or paper to the finished product. Contact the factory for additional color options.

¹ Birch is not available in 1.5 MM

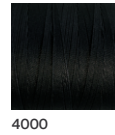

SURFACE STYLES

PLN-U

9MM FELT

DATE	PROJECT	CATALOG #	FIXTURE TYPE
------	---------	-----------	--------------

Our foundational surface styles utilize our 9mm felt and are designed to accommodate distinctly unique design expressions. Contact the factory for custom colors and styles. Each style is available in 16 colors.

FINE FLUTE

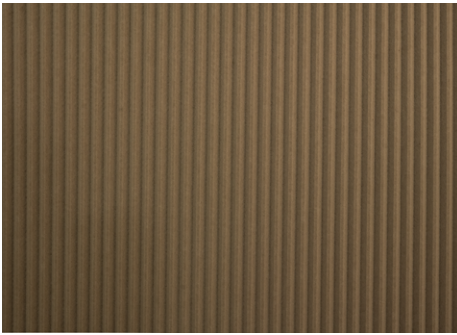

MID FLUTE

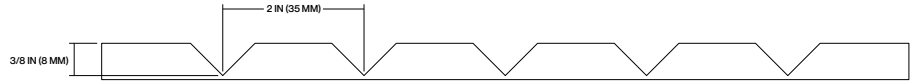

WIDE FLUTE

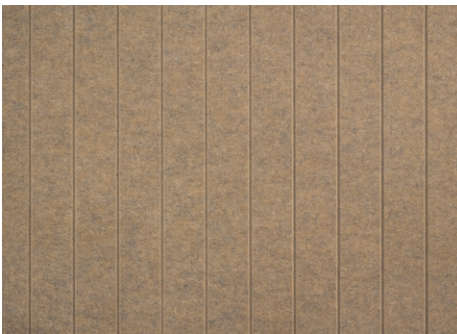

DIMENSIONS

PLN-U

DATE	PROJECT	CATALOG #	FIXTURE TYPE
------	---------	-----------	--------------

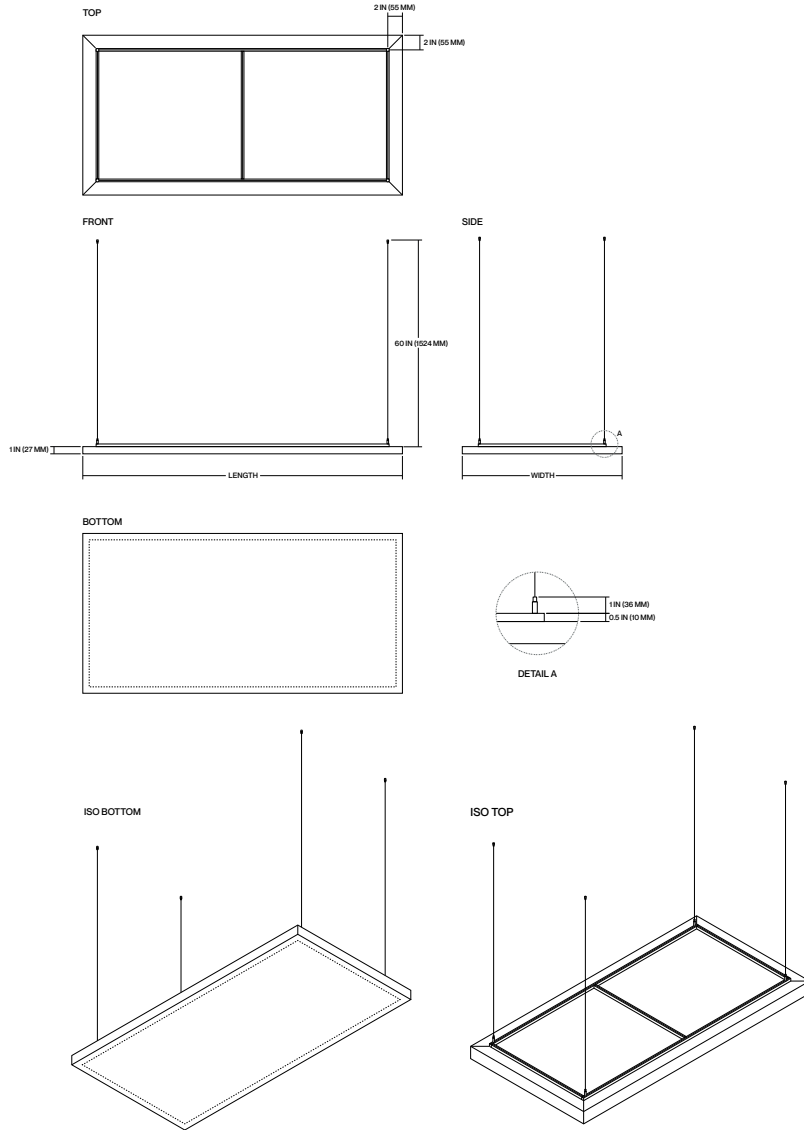

- 1 IMPERIAL DIMENSIONS ARE NOMINAL. ACTUAL DIMENSIONS ARE METRIC.
- 2 ALL STANDARD DIMENSIONS ARE ECO-CONSCIOUS, MAXIMIZING MATERIAL USE AND MINIMIZING WASTE. CUSTOM DIMENSIONS RESULT IN EXCESS MATERIAL WASTE.
- 3 PLEASE CONSULT THE FACTORY FOR WEIGHTS SPECIFIC TO CONFIGURATION.

PLANE

UNLIT - SUSPENDED

PLN-U

DATE	PROJECT	CATALOG #	FIXTURE TYPE
------	---------	-----------	--------------

DIMENSIONS - FINE FLUTE SURFACE STYLE

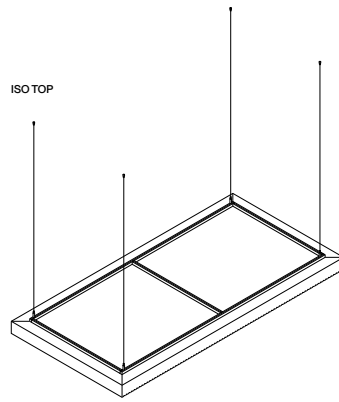
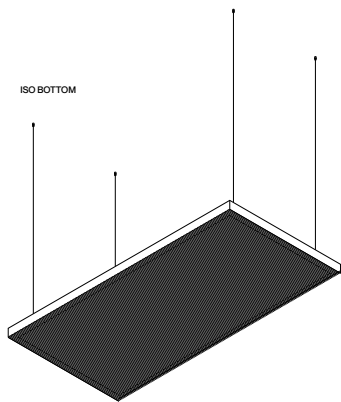
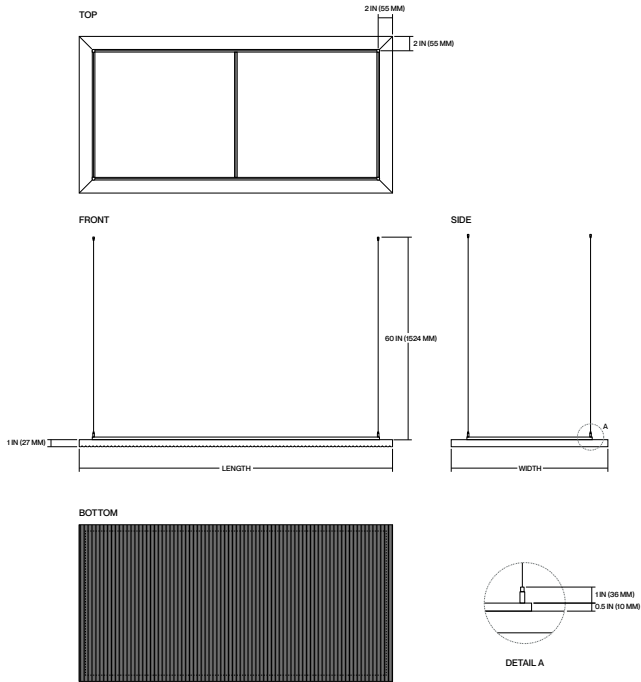

- 1 IMPERIAL DIMENSIONS ARE NOMINAL. ACTUAL DIMENSIONS ARE METRIC.
- 2 ALL STANDARD DIMENSIONS ARE ECO-CONSCIOUS, MAXIMIZING MATERIAL USE AND MINIMIZING WASTE. CUSTOM DIMENSIONS RESULT IN EXCESS MATERIAL WASTE.
- 3 PLEASE CONSULT THE FACTORY FOR WEIGHTS SPECIFIC TO CONFIGURATION.

SABIN

© 2025 SABIN LLC. ALL RIGHTS RESERVED.
CUSTOMIZE AT SABIN.BUILD
DATE REVISED 09.23.2025

MADE
IN THE
USA

YEAR
5
WARRANTY



5

PLANE

UNLIT - SUSPENDED

PLN-U

DATE	PROJECT	CATALOG #	FIXTURE TYPE
------	---------	-----------	--------------

DIMENSIONS - MID FLUTE SURFACE STYLE

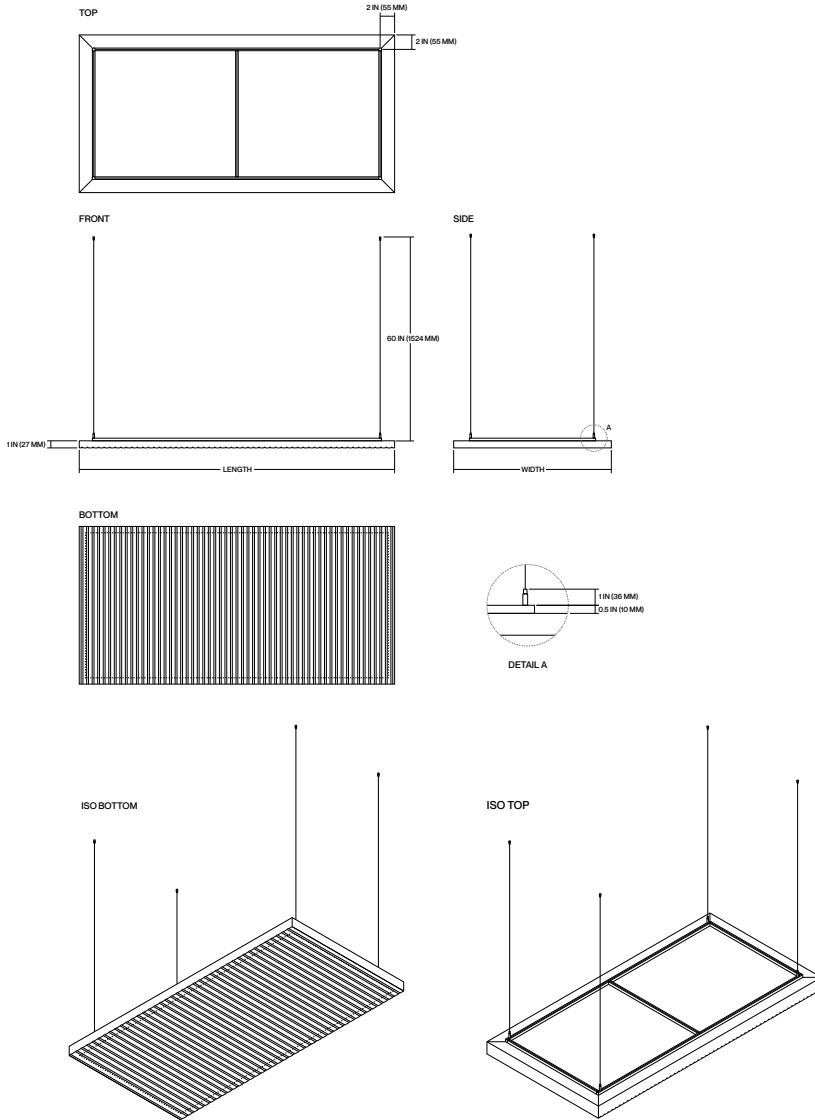

- 1 IMPERIAL DIMENSIONS ARE NOMINAL. ACTUAL DIMENSIONS ARE METRIC.
- 2 ALL STANDARD DIMENSIONS ARE ECO-CONSCIOUS, MAXIMIZING MATERIAL USE AND MINIMIZING WASTE. CUSTOM DIMENSIONS RESULT IN EXCESS MATERIAL WASTE.
- 3 PLEASE CONSULT THE FACTORY FOR WEIGHTS SPECIFIC TO CONFIGURATION.

PLANE

UNLIT - SUSPENDED

PLN-U

DATE	PROJECT	CATALOG #	FIXTURE TYPE
------	---------	-----------	--------------

DIMENSIONS - WIDE FLUTE SURFACE STYLE

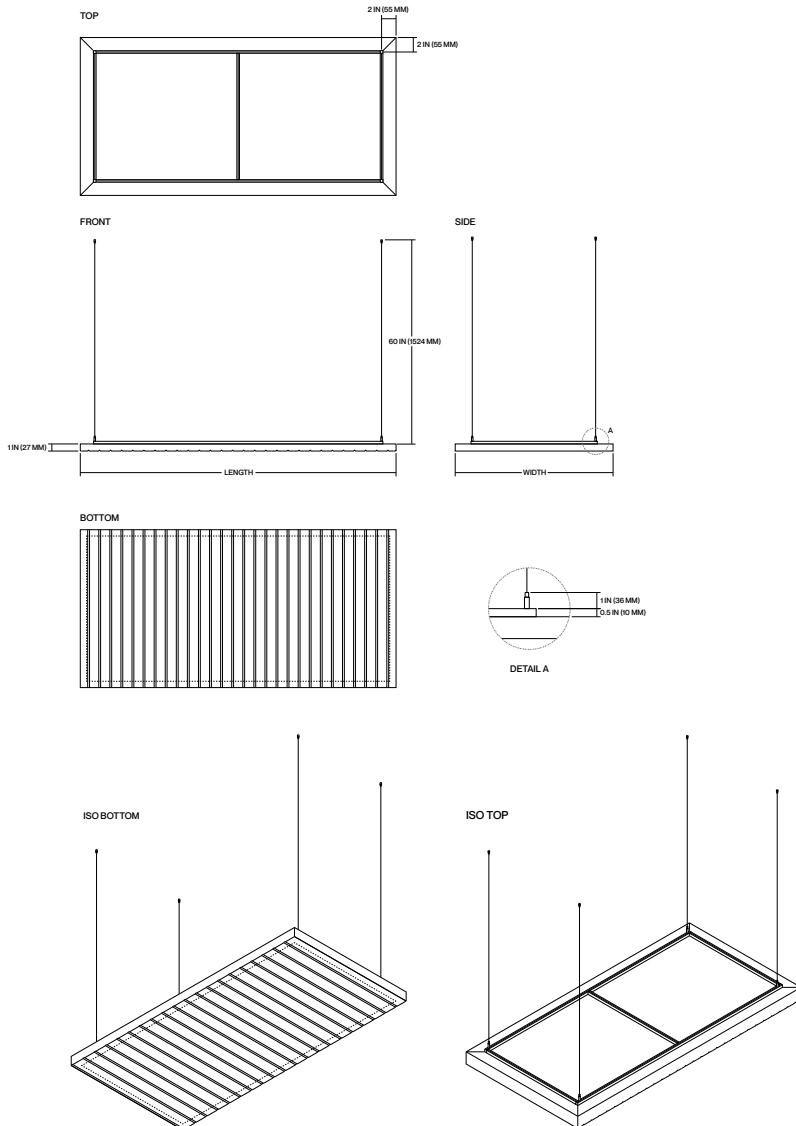

- 1 IMPERIAL DIMENSIONS ARE NOMINAL. ACTUAL DIMENSIONS ARE METRIC.
- 2 ALL STANDARD DIMENSIONS ARE ECO-CONSCIOUS. MAXIMIZING MATERIAL USE AND MINIMIZING WASTE. CUSTOM DIMENSIONS RESULT IN EXCESS MATERIAL WASTE.
- 3 PLEASE CONSULT THE FACTORY FOR WEIGHTS SPECIFIC TO CONFIGURATION.

ACOUSTIC PERFORMANCE

PLN-U

TECHNICAL DATA

DATE	PROJECT	CATALOG #	FIXTURE TYPE
------	---------	-----------	--------------

PLANE

ALL SABIN PRODUCTS ARE SUBJECT TO ACOUSTIC TESTING. PERFORMANCE VALUES WILL VARY BASED ON INSTALLATION FACTORS SUCH AS DENSITY AND MOUNTING HEIGHT.

SABINS A SABIN IS A UNIT OF SOUND ABSORPTION DEFINED AS THE AMOUNT OF SOUND ABSORBED BY ONE SQUARE FOOT OF A PERFECT ABSORBER. IT WAS INITIALLY CONCEIVED AS THE EQUIVALENT OF 1 SQUARE FOOT OF OPEN WINDOW, REFLECTING NO SOUND BACK INTO THE INTERIOR. SABINS ARE USED TO EXPRESS THE TOTAL EFFECTIVE ABSORPTION FOR THE INTERIOR OF A ROOM. THIS CHART INDICATES AVERAGE SABINS PER UNIT AT THE NOTED FREQUENCIES WHICH REPRESENT THE TYPICAL RANGE OF HUMAN SPEECH OF 200-2500 HZ.

NRC NOISE REDUCTION COEFFICIENT (NRC) IS A SINGLE NUMBER VALUE RANGING FROM 0.0 TO 1.0 THAT DESCRIBES THE AVERAGE SOUND ABSORPTION PERFORMANCE OF A MATERIAL. AN NRC OF 0.0 INDICATES THE OBJECT DOES NOT ABSORB MID-FREQUENCY SOUND ENERGY, BUT REFLECTS IT. AN NRC OF 1.0 INDICATES THAT THE SOUND ABSORPTION PERFORMANCE OF THE MATERIAL IS EQUAL TO ITS SURFACE AREA (MEASURED IN UNITS SABIN), OR CONCEPTUALLY 100% SOUND ABSORPTION.

PROJECTED NRC = .95

TOTAL SOUND ABSORPTION WILL VARY BASED ON DESIGNED PRODUCT CONFIGURATION. SABIN TESTS ALL PRODUCTS IN MULTIPLE CONFIGURATIONS. PLEASE CONTACT SABIN OR YOUR LOCAL AGENT FOR MORE INFORMATION.

PLANE
ACOUSTIC PERFORMANCE

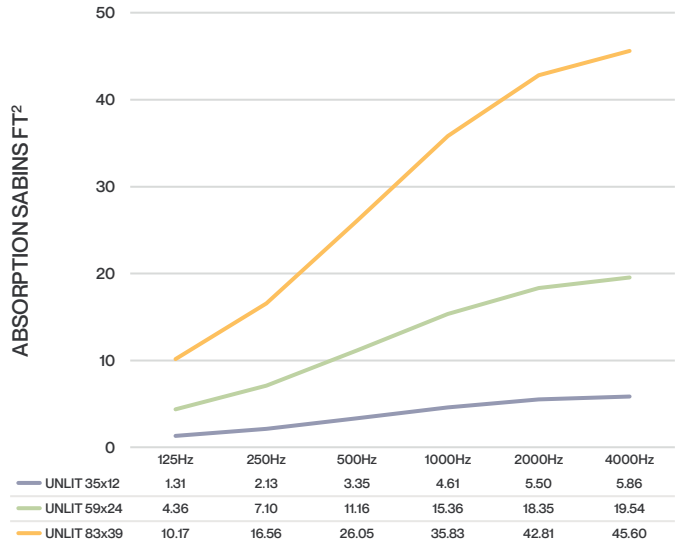

DATE	PROJECT	CATALOG #	FIXTURE TYPE

ACOUSTIC MATERIAL

Our PET (polyester) felt panels contain minimum 60% post-consumer recycled polyester staple fiber. It is moisture resistant, fire rated, recyclable, and an outstanding absorber of acoustic energy.

- Fire retardant: ASTM E84 Class A, EN13501 Class B
- Construction: 100% polyester fiber (PET)
- Material certifications: OEKO-TEX® Standard 100, SCS Recycled Content, and Declare

CARE

Acoustic PET felt: Remove dust with compressed air, a vacuum or lint roller. Aluminum & polymer components: Remove dust and debris with a clean, dry, lint-free cloth.

CERTIFICATES/LISTING

This product is ETL listed and tested to meet UL standards for lit configurations. It complies with NEC and ANSI/NFPA 70 requirements, is RoHS compliant, and rated IP20 for use in dry, indoor locations only. 90 CRI configurations also meet Title 24 JA8-2016 requirements. Additionally, this product is GREENGUARD Gold certified and holds Declare, OEKO-TEX® Standard 100, and SCS Recycled Content certifications.

CONSTRUCTION

Acoustic luminaire comprised of ≥ 60% recycled PET material utilizing sewn construction to maximize strength, durability, and sound absorbency.

MOUNTING

Suspended by various methods including 1/16" aircraft cable, straps, grid clips or 3/8" threaded rod (adapters provided, threaded rod by others). Aircraft cable is available in pre-cut lengths of 60" (1524 MM) or custom length from 24" (600 MM) to 120" (3048 MM). For lit units, fabric-covered power cord is provided along with a 5" (127 MM) feed canopy.

WARRANTY

Fixture rated for operation in conditioned environments up to 77°F (25°C). Fixture is warranted to be free from defects and/or failure under normal Use and proper storage for five (5) years from date of shipment.

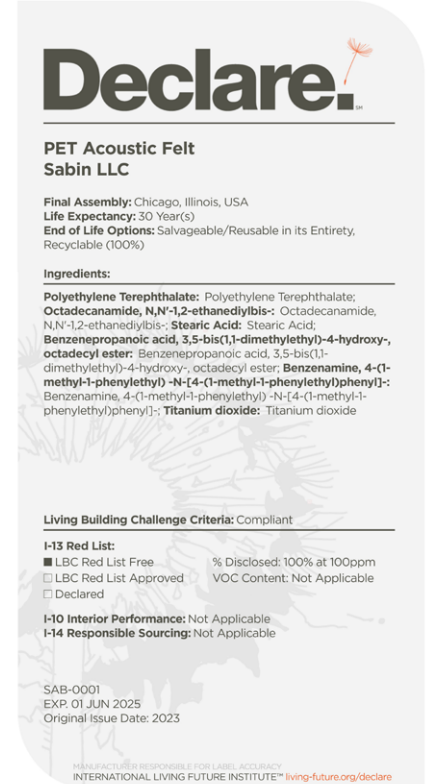

CONSULT FACTORY FOR SPECIFIC PRODUCT CONFIGURATIONS.