

QUAD

LIT - DIFFUSE

QUD-L-DF

DATE	PROJECT	CATALOG #	FIXTURE TYPE
------	---------	-----------	--------------

OVERVIEW

Crafted with our signature sewn construction, QUAD is a design-forward acoustic pendant. With heights reaching up to 100 IN, options for light engines by others, and unlit configurations, QUAD seamlessly transforms into pendant, array, or cloud formations, making it ideal for high-performance lighting and acoustic systems.

QUICK FACTS

- Direct, indirect, or bidirectional light output
- Available in 2700/3000/3500/4000 CCT at 90+ Color Rendering Index (CRI)
- Custom lengths between 24 - 47 IN and heights between 12 - 100 IN
- Diffuse engine sizes: 16 x 16, 24 x 24, 35 x 35, or 47 x 47 IN
- NRC rating of .95



SPECIFICATIONS

SERIES	LENGTH/WIDTH ¹	HEIGHT ¹	LENS SIZE ⁴	DIRECT OUTPUT ⁵	INDIRECT OUTPUT ⁶	
QUD-L-DF	16" X 16" (406 MM X 406 MM) 24" X 24" (606 MM X 606 MM) 35" X 35" (906 MM X 906 MM) 47" X 47" (1206 MM X 1206 MM) CLW___ ²	12" (300 MM) 19" (475 MM) 24" (600 MM) 33" (850 MM) 53" (1350 MM) 100" (2550 MM) CH___ ³	QS 16" X 16" (400 MM X 400 MM): 5000 LM MAX QM 24" X 24" (600 MM X 600 MM): 5000 LM MAX QL 35" X 35" (900 MM X 900 MM): 12000 LM MAX QXL 47" X 47" (1200 MM X 1200 MM): 18000 LM MAX	D___ REPLACE "___" WITH DESIRED LUMEN OUTPUT ⁵	INA NO OUTPUT I750 750 LM I1000 1000 LM I1500 1500 LM I3000 3000 LM CIO___ CUSTOM OUTPUT ⁷	
CRI/CCT	CIRCUIT	CONTROL	VOLTAGE	EXTERIOR FELT (1.5 MM)	INTERIOR FELT (1.5 MM)	PIPING
927K 930K 935K 940K	SC SINGLE CIRCUIT DC DUAL CIRCUIT (SHARED DIMMING)	10 0-10V TO 1%	UNV 120V/ 277V	15___ REPLACE "___" WITH DESIRED COLOR CODE FROM SWITCHES	15___ REPLACE "___" WITH DESIRED COLOR CODE FROM SWITCHES	NP NO PIPING P___ REPLACE "___" WITH DESIRED COLOR CODE FROM SWITCHES
CORD COLOR ⁸	SUSPENSION TYPE	CEILING TYPE	CANOPY ¹¹	FACTORY OPTIONS ¹²		
PC___ REPLACE "___" WITH DESIRED COLOR CODE FROM SWITCHES	AC___ 60" AIRCRAFT CABLE + (COLOR CODE) ⁹ ST___ 60" STRAP + (COLOR CODE) ⁹ TRD 3/8" THREADED ROD DT DIRECT TO	HC HARD CEILING ¹⁰ ST STRUT SG STANDARD GRID TG TEGULAR GRID	RWH ROUND WHITE RBK ROUND BLACK SWH SQUARE WHITE SBK SQUARE BLACK	CSL___ CUSTOM SUSPENSION LENGTH 24" - 120" ¹³ EM EMERGENCY BATTERY CT___ CUSTOM THREAD + (COLOR CODE) ⁹ 2CP INCLUDE 2" CANOPIES CF CENTER FEED BABA BABA REQUIRED		

1 IMPERIAL DIMENSIONS ARE NOMINAL. ACTUAL DIMENSIONS ARE METRIC.
2 CUSTOM LENGTHS/WIDTHS AVAILABLE BETWEEN 24" - 47" (606 - 1206 MM).
3 CUSTOM HEIGHTS AVAILABLE BETWEEN 12" - 100" (300 - 2550 MM).
4 LENS SIZE NEEDS TO BE EQUAL TO OR LESS THAN FIXTURE SIZE.
5 MINIMUM 2000 LM OUTPUT.
6 MINIMUM HEIGHT OF 19" (475 MM) FOR INDIRECT OUTPUT.
7 CONSULT FACTORY.

8 POWER CABLE IS 18" LONGER THAN SUSPENSION LENGTH. CONSULT FACTORY FOR LONGER LENGTHS.
9 REPLACE "___" WITH DESIRED COLOR CODE FROM SWITCHES.
10 NOT AVAILABLE IN DIRECT TO SUSPENSION TYPE.
11 5" (127 MM) CANOPY PROVIDED FOR FEED. 2" (50.8 MM) CANOPIES FOR NON-FEED UPON REQUEST.
12 LEAVE BLANK IF NOT APPLICABLE. STRING TOGETHER MULTIPLE SELECTIONS.
13 REPLACE "___" WITH LENGTH OF DESIRED SUSPENSION.

EXAMPLE CATALOG #: QUD-L-DF-47(1206)-47(1206)-53(1350)-QL-D5000-I1000-940K-DC-10-UNV-15FL-15MO-NP-PCBR-ACSLV-HC-RWH

SABIN

© 2025 SABIN LLC. ALL RIGHTS RESERVED.
CUSTOMIZE AT SABIN.BUILD
DATE REVISED 09.30.2025



COLOR SWATCHES

QUD-L-DF

DATE	PROJECT	CATALOG #	FIXTURE TYPE
------	---------	-----------	--------------

FELT



PIPING



POWER CORD



AIRCRAFT CABLE

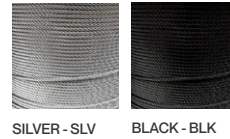

THREAD



SUSPENSION STRAP

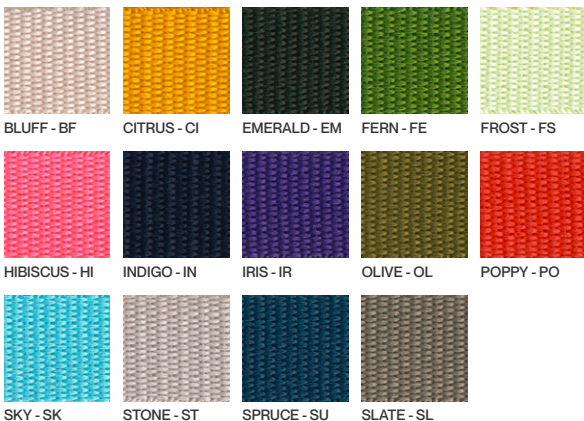

SIZE COMBINATIONS

QUD-L-DF

DATE	PROJECT	CATALOG #	FIXTURE TYPE
------	---------	-----------	--------------

FIXTURE SIZE	LIGHT ENGINE SIZE			
	16" X 16" (406 MM X 406 MM)	24" X 24" (606 MM X 606 MM)	35" X 35" (906 MM X 906 MM)	47" X 47" (1206 MM X 1206 MM)

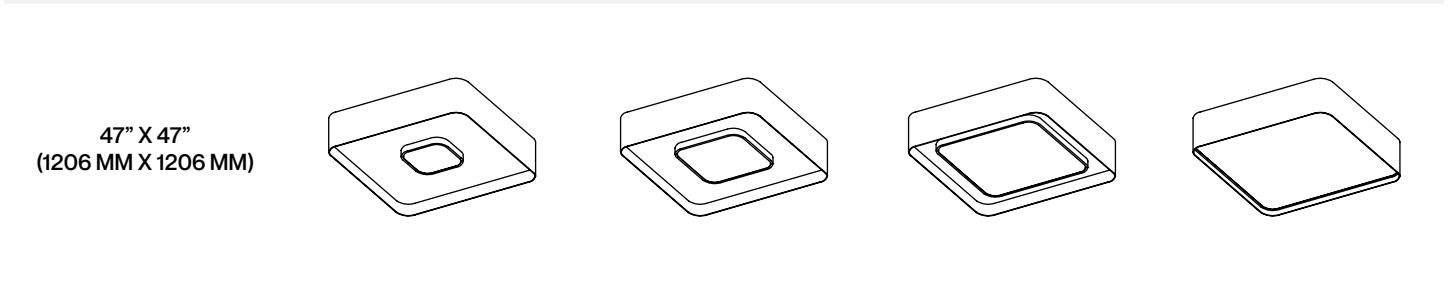
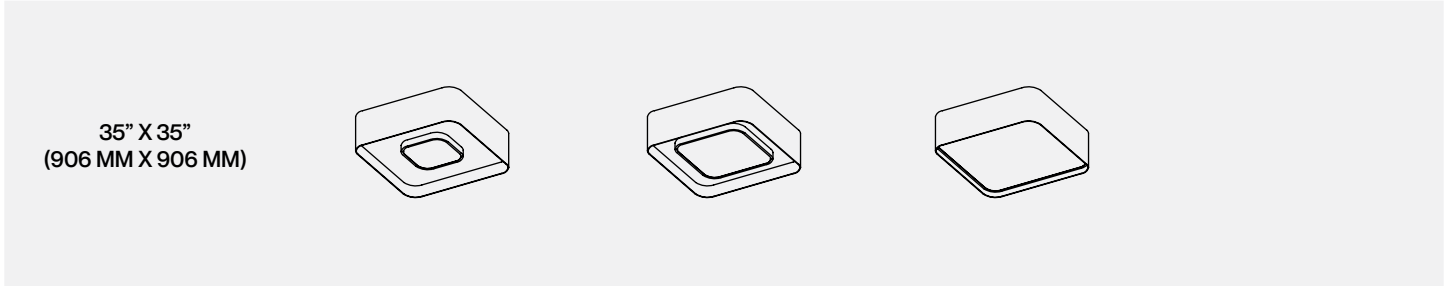
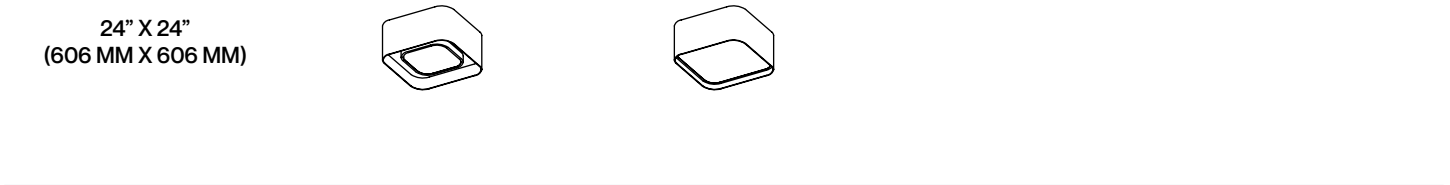
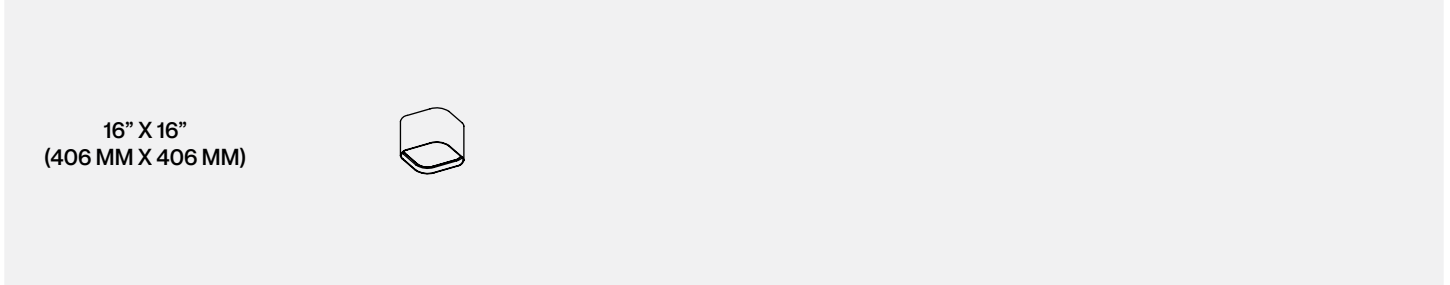

DIMENSIONS

QUD-L-DF

DATE	PROJECT	CATALOG #	FIXTURE TYPE
------	---------	-----------	--------------

FULL DIFFUSE

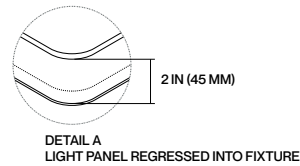
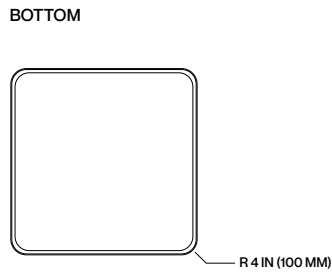
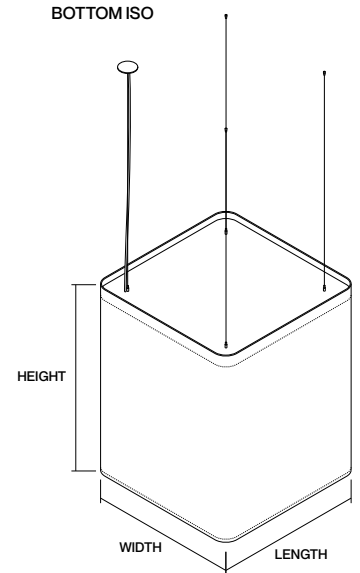
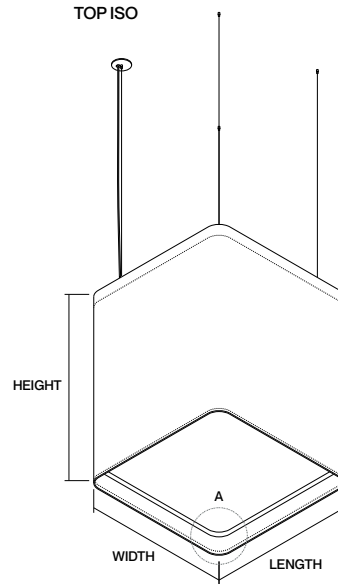
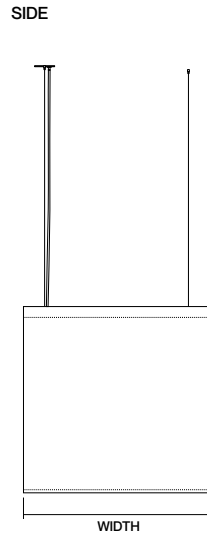
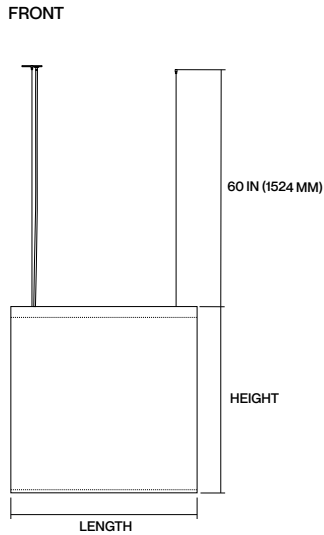
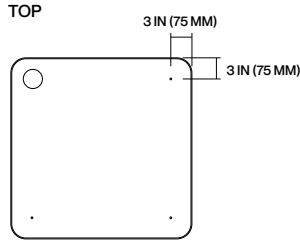

- 1 IMPERIAL DIMENSIONS ARE NOMINAL. ACTUAL DIMENSIONS ARE METRIC.
- 2 ALL STANDARD DIMENSIONS ARE ECO-CONSCIOUS, MAXIMIZING MATERIAL USE AND MINIMIZING WASTE. CUSTOM DIMENSIONS RESULT IN EXCESS MATERIAL WASTE.
- 3 PLEASE CONSULT THE FACTORY FOR WEIGHTS SPECIFIC TO CONFIGURATION.

DIMENSIONS

QUD-L-DF

DATE	PROJECT	CATALOG #	FIXTURE TYPE
------	---------	-----------	--------------

PARTIAL DIFFUSE

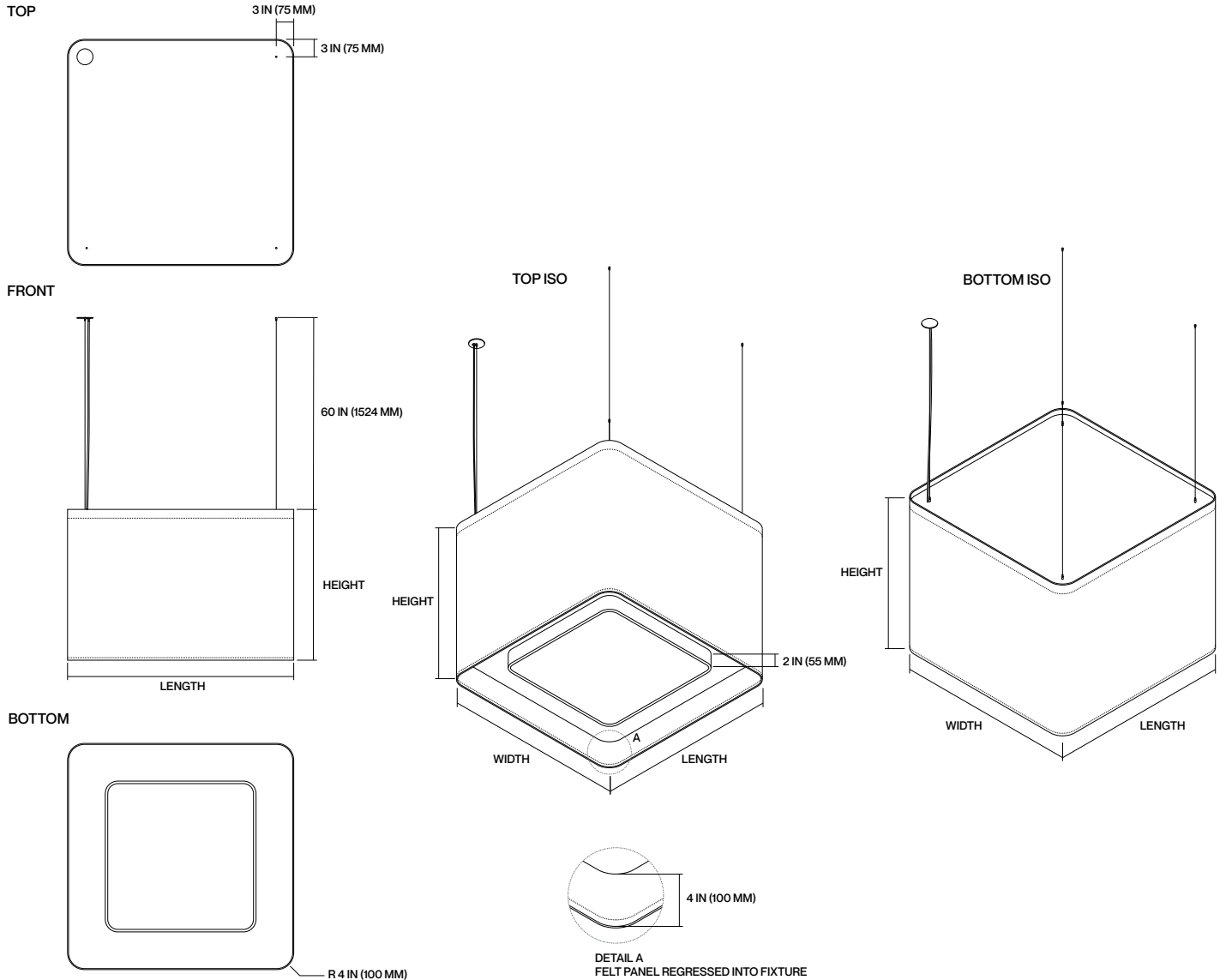

- 1 IMPERIAL DIMENSIONS ARE NOMINAL. ACTUAL DIMENSIONS ARE METRIC.
- 2 ALL STANDARD DIMENSIONS ARE ECO-CONSCIOUS. MAXIMIZING MATERIAL USE AND MINIMIZING WASTE. CUSTOM DIMENSIONS RESULT IN EXCESS MATERIAL WASTE.
- 3 PLEASE CONSULT THE FACTORY FOR WEIGHTS SPECIFIC TO CONFIGURATION.

ACOUSTIC PERFORMANCE

QUAD-L-DF

TECHNICAL DATA

DATE	PROJECT	CATALOG #	FIXTURE TYPE
------	---------	-----------	--------------

QUAD

ALL SABIN PRODUCTS ARE SUBJECT TO ACOUSTIC TESTING. PERFORMANCE VALUES WILL VARY BASED ON INSTALLATION FACTORS SUCH AS DENSITY AND MOUNTING HEIGHT.

SABINS A SABIN IS A UNIT OF SOUND ABSORPTION DEFINED AS THE AMOUNT OF SOUND ABSORBED BY ONE SQUARE FOOT OF A PERFECT ABSORBER. IT WAS INITIALLY CONCEIVED AS THE EQUIVALENT OF 1 SQUARE FOOT OF OPEN WINDOW, REFLECTING NO SOUND BACK INTO THE INTERIOR. SABINS ARE USED TO EXPRESS THE TOTAL EFFECTIVE ABSORPTION FOR THE INTERIOR OF A ROOM. THIS CHART INDICATES AVERAGE SABINS PER UNIT AT THE NOTED FREQUENCIES WHICH REPRESENT THE TYPICAL RANGE OF HUMAN SPEECH OF 200-2500 HZ.

NRC NOISE REDUCTION COEFFICIENT (NRC) IS A SINGLE NUMBER VALUE RANGING FROM 0.0 TO 1.0 THAT DESCRIBES THE AVERAGE SOUND ABSORPTION PERFORMANCE OF A MATERIAL. AN NRC OF 0.0 INDICATES THE OBJECT DOES NOT ABSORB MID-FREQUENCY SOUND ENERGY, BUT REFLECTS IT. AN NRC OF 1.0 INDICATES THAT THE SOUND ABSORPTION PERFORMANCE OF THE MATERIAL IS EQUAL TO ITS SURFACE AREA (MEASURED IN UNITS SABIN), OR CONCEPTUALLY 100% SOUND ABSORPTION.

PROJECTED NRC = .95

TOTAL SOUND ABSORPTION WILL VARY BASED ON DESIGNED PRODUCT CONFIGURATION. SABIN TESTS ALL PRODUCTS IN MULTIPLE CONFIGURATIONS. PLEASE CONTACT SABIN OR YOUR LOCAL AGENT FOR MORE INFORMATION.

QUAD
ACOUSTIC PERFORMANCE

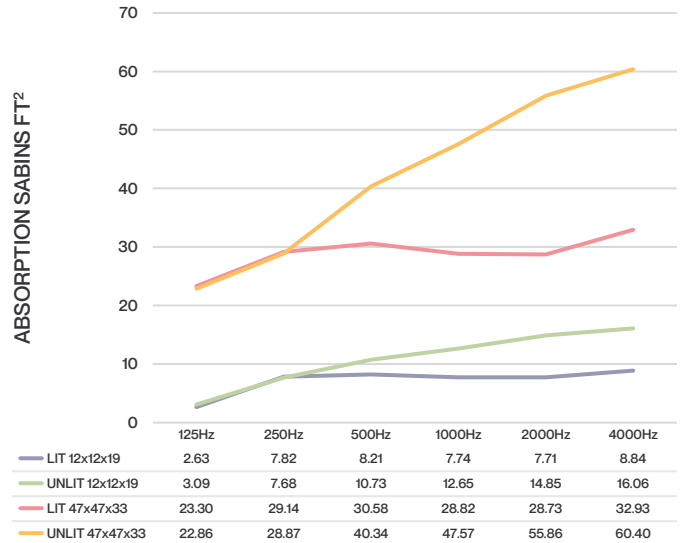

LIGHTING PERFORMANCE

QUAD-L-DF

TECHNICAL DATA

DATE	PROJECT	CATALOG #	FIXTURE TYPE
------	---------	-----------	--------------

QUAD

LIT - DIFFUSE

PHOTOMETRIC PLOTS

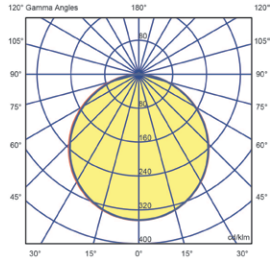

SIZE ALL
 WATTAGE 42.7
 LUMENS 5224.2

DELIVERED LUMENS AND ENERGY USE

SIZE	OUTPUT (LUMENS)	DELIVERED (LUMENS)	ENERGY (WATTS)	EFFICACY (LPW)
24" (600 MM)	D2000	2000	16.93	118.12
	D3500	3500	29.10	120.28
	D5000	5000	40.92	122.20
35" (900 MM)	D8000	8000	63.81	125.37
	D10000	10000	78.76	126.97
	D12000	12000	93.62	128.18
47" (1200 MM)	D14000	14000	108.55	128.97
	D16000	16000	123.69	129.36
	D18000	18000	139.16	129.35

*Based on 3500k, ≥90CRI. Lumen output and wattage may vary +/-5%.

CCT MULTIPLIER

CCT	2700K	3000K	3500K	4000K
CRI	90	90	90	90
MULTIPLIER	0.87	0.88	1	0.90

DATE	PROJECT	CATALOG #	FIXTURE TYPE
------	---------	-----------	--------------

ACOUSTIC MATERIAL

Our PET (polyester) felt panels contain minimum 60% post-consumer recycled polyester staple fiber. It is moisture resistant, fire rated, recyclable, and an outstanding absorber of acoustic energy.

- Fire retardant: ASTM E84 Class A, EN13501 Class B
- Construction: 100% polyester fiber (PET)
- Material certifications: OEKO-TEX® Standard 100, SCS Recycled Content, and Declare

CARE

Acoustic PET felt: Remove dust with compressed air, a vacuum or lint roller. Aluminum & polymer components: Remove dust and debris with a clean, dry, lint-free cloth.

CERTIFICATES/LISTING

This product is ETL listed and tested to meet UL standards for lit configurations. It complies with NEC and ANSI/NFPA 70 requirements, is RoHS compliant, and rated IP20 for use in dry, indoor locations only. 90 CRI configurations also meet Title 24 JA8-2016 requirements. Additionally, this product is GREENGUARD Gold certified and holds Declare, OEKO-TEX® Standard 100, and SCS Recycled Content certifications.

CONSTRUCTION

Acoustic luminaire comprised of ≥ 60% recycled PET material utilizing sewn construction to maximize strength, durability, and sound absorbency.

DIMMING (LIT ONLY)

Standard 120-277V constant current driver includes 0-10V analog dimming to 1%. Options for Lutron EcoSystem at 120/277V, TRIAC/ELV DALI, DMX, and Warm Dim available on select products. Consult factory.

ELECTRICAL (LIT ONLY)

High quality Class P isolated power supply with universal (120-277VAC) and 347V input voltage. Meets UL operation rating dry & damp (IP40) max 185°F (85°C) for 50,000 hour life. Luminaries are pre-wired with factory installed branch circuit wiring.

Power Factor:

- 0.95 @ 120VAC
- 0.90 @ 277VAC
- 0.90 @ 347VAC

For fixtures specified with an emergency battery/driver: 6W-20W integral battery (output dependent) with self-testing/metal test switch/indicator light (bi-color). Up to 15% of total lumen output for a minimum of 90 minutes. Listed to UL924 and tested to CSA 22.2 No.141 Field or Factory Installation (Indoor and Damp). Output Class 2 Compliant. Input CEC Title 20 Compliant.

ESTIMATED LIFETIME (LIT ONLY)

L70 = >60,000 Hours. Luminous flux maintenance life L70(9k) based on IES TM-28-147 9000-hour test at Ta= 45°C.

CONSULT FACTORY FOR SPECIFIC PRODUCT CONFIGURATIONS.

SABIN

© 2024 SABIN LLC. ALL RIGHTS RESERVED.
 CUSTOMIZE AT SABIN.BUILD
 DATE REVISED 09.30.2025

LED LIGHT ENGINE (LIT ONLY)

Light module incorporates premium LEDs with heat sink to maximum lifetime. Available in 2700K, 3000K, 3500K or 4000K CCT with ≥90 CRI. Color accuracy = minimum 2.2x SDCM @ 3000K ±66K ΔUV +0.0004 Standard deviation color matching (SDCM) based on ANSI standard C78.377A indicating the visible variance in correlated color temperature, also referred to as “MacAdam ellipse.”

MOUNTING

Suspended by various methods including 1/16” aircraft cable, straps, grid clips or 3/8” threaded rod (adapters provided, threaded rod by others). Aircraft cable is available in precut lengths of 60” (1524 MM) or custom length from 24” (600 MM) to 120” (3048 MM). For lit units, fabric-covered power cord is provided along with a 5” (127 MM) feed canopy.

OPTICS (LIT ONLY)

Injection molded, cut or extruded acrylic lens designed for efficient and homogeneous light distribution with superior color over angle performance. Beam control available on select configurations down to 15° and up to +90°. Optics are field changeable.

WARRANTY

Fixture rated for operation in conditioned environments up to 77°F (25°C). Fixture is warranted to be free from defects and/or failure under normal use and proper storage for five (5) years from date of shipment.



Declare.

PET Acoustic Felt
Sabin LLC

Final Assembly: Chicago, Illinois, USA
 Life Expectancy: 30 Year(s)
 End of Life Options: Salvageable/Reusable in its Entirety,
 Recyclable (100%)

Ingredients:

Polyethylene Terephthalate: Polyethylene Terephthalate;
 Octadecanamide, N,N'-1,2-ethanedilylbis-: Octadecanamide,
 N,N'-1,2-ethanedilylbis-; Stearic Acid: Stearic Acid;
 Benzenepropanoic acid, 3,5-bis(1,1-dimethylethyl)-4-hydroxy-,
 octadecyl ester: Benzenepropanoic acid, 3,5-bis(1,1-
 dimethylethyl)-4-hydroxy-, octadecyl ester; Benzenamine, 4-(1-
 methyl-1-phenylethyl)-N-[4-(1-methyl-1-phenylethyl)phenyl]-:
 Benzenamine, 4-(1-methyl-1-phenylethyl)-N-[4-(1-methyl-1-
 phenylethyl)phenyl]; Titanium dioxide: Titanium dioxide

Living Building Challenge Criteria: Compliant

I-13 Red List:

- LBC Red List Free % Disclosed: 100% at 100ppm
- LBC Red List Approved VOC Content: Not Applicable
- Declared

I-10 Interior Performance: Not Applicable
I-14 Responsible Sourcing: Not Applicable

SAB-0001
 EXP. 01 JUN 2025
 Original Issue Date: 2023

MANUFACTURER RESPONSIBLE FOR LABEL ACCURACY
 INTERNATIONAL LIVING FUTURE INSTITUTE™ living-future.org/declare

