

# QUAD

## LIT - DOWNLIGHT

# QUD-L-DL

DATE	PROJECT	CATALOG #	FIXTURE TYPE
------	---------	-----------	--------------

### OVERVIEW

Crafted with our signature sewn construction, QUAD is a design-forward acoustic pendant. With heights reaching up to 100 IN, options for light engines by others, and unlit configurations, QUAD seamlessly transforms into pendant, array, or cloud formations, making it ideal for high-performance lighting and acoustic systems.

### QUICK FACTS

- Direct, indirect, or bidirectional light output
- Downlights have multiple beam spreads: 15°, 25°, 40°, 60°, and 90°
- Available in 2700/3000/3500/4000 CCT at 90+ Color Rendering Index (CRI)
- Custom lengths between 16 - 47 IN and heights between 12 - 100 IN
- NRC rating of .95



## SPECIFICATIONS

SERIES	LENGTH/WIDTH <sup>1</sup>	HEIGHT <sup>1</sup>	DIRECT OUTPUT	DIRECT OPTIC	DIRECT TRIM	INDIRECT OUTPUT <sup>5,6</sup>	CRI/CCT
QUD-L-DL	16" X 16" (400 MM X 400 MM) 24" X 24" (600 MM X 600 MM) 35" X 35" (900 MM X 900 MM) 47" X 47" (1200 MM X 1200 MM) CLW___ <sup>2</sup>	12" (300 MM) 19" (475 MM) 24" (600 MM) 33" (850 MM) 53" (1350 MM) 100" (2550 MM) CH___ <sup>3</sup>	D750 750 LM D1000 1000 LM D1500 1500 LM D2000 2000 LM D2500 2500 LM D3000 3000 LM D3500 3500 LM	DNS 15° NARROW SPOT <sup>4</sup> DSP 25° SPOT DFL 40° FLOOD DWF 60° WIDE FLOOD DGA +90° GENERAL AMBIENT <sup>4</sup>	LRW ROUND WHITE LRB ROUND BLACK	INA NO OUTPUT I750 750 LM I1000 1000 LM I1500 1500 LM I3000 3000 LM CIO___ CUSTOM OUTPUT <sup>7</sup>	927K 930K 935K 940K
CIRCUIT	CONTROL	VOLTAGE	EXTERIOR FELT (1.5 MM)	INTERIOR FELT (1.5 MM)	PIPING		
SC SINGLE CIRCUIT DC DUAL CIRCUIT (SHARED DIMMING)	10 0-10V TO 1%	UNV 120V/277V	15___ REPLACE "___" WITH DESIRED COLOR CODE FROM SWITCHES	15___ REPLACE "___" WITH DESIRED COLOR CODE FROM SWITCHES	NP NO PIPING P___ REPLACE "___" WITH DESIRED COLOR CODE FROM SWITCHES		
CORD COLOR <sup>8</sup>	SUSPENSION TYPE	CEILING TYPE	CANOPY <sup>11</sup>	FACTORY OPTIONS <sup>12</sup>			
PC___ REPLACE "___" WITH DESIRED COLOR CODE FROM SWITCHES	AC___ 60" AIRCRAFT CABLE + (COLOR CODE) <sup>9</sup> ST___ 60" STRAP + (COLOR CODE) <sup>9</sup> TRD 3/8" THREADED ROD DT DIRECT TO	HC HARD CEILING <sup>10</sup> ST STRUT SG STANDARD GRID TG TEGULAR GRID	RWH ROUND WHITE RBK ROUND BLACK SWH SQUARE WHITE SBK SQUARE BLACK	CSL___ CUSTOM SUSPENSION LENGTH 24" - 120" <sup>13</sup> EM EMERGENCY BATTERY <sup>14</sup> CT___ CUSTOM THREAD + (COLOR CODE) <sup>9</sup> 2CP INCLUDE 2" CANOPIES CF CENTER FEED BABA BABA REQUIRED			

1 IMPERIAL DIMENSIONS ARE NOMINAL. ACTUAL DIMENSIONS ARE METRIC.  
2 CUSTOM LENGTH/WIDTH AVAILABLE BETWEEN 16" - 47" (400 - 1200 MM).  
3 CUSTOM HEIGHTS AVAILABLE BETWEEN 12" - 100" (300 MM - 2550 MM).  
4 ONLY AVAILABLE UP TO 2000 LM.  
5 ONLY AVAILABLE IN LAMBERTIAN DISTRIBUTION.  
6 MINIMUM HEIGHT OF 19" (475 MM) FOR INDIRECT OUTPUT.  
7 CONSULT FACTORY.

8 POWER CABLE IS 18" LONGER THAN SUSPENSION LENGTH. CONSULT FACTORY FOR LONGER LENGTHS.  
9 REPLACE "\_\_\_" WITH DESIRED COLOR CODE FROM SWITCHES.  
10 NOT AVAILABLE IN DIRECT TO SUSPENSION TYPE.  
11 5" (127 MM) CANOPY PROVIDED FOR FEED. 2" (50.8 MM) CANOPIES FOR NON-FEED UPON REQUEST.  
12 LEAVE BLANK IF NOT APPLICABLE. STRING TOGETHER MULTIPLE SELECTIONS.  
13 REPLACE "\_\_\_" WITH LENGTH OF DESIRED SUSPENSION.  
14 ONLY AVAILABLE WITH DIRECT TRIM - ROUND WHITE.

EXAMPLE CATALOG #: QUD-L-DL-47(1200)-47(1200)-33(850)-D750-DNS-LRW-I750-927K-DC-10-UNV-15PN-15PN-PFE-PCGR-TRD-HC-RWH-EM-CF

# COLOR SWATCHES

# QUD-L-DL

DATE	PROJECT	CATALOG #	FIXTURE TYPE
------	---------	-----------	--------------

## FELT



## PIPING



## POWER CORD



## AIRCRAFT CABLE

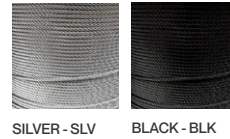

## THREAD



## SUSPENSION STRAP

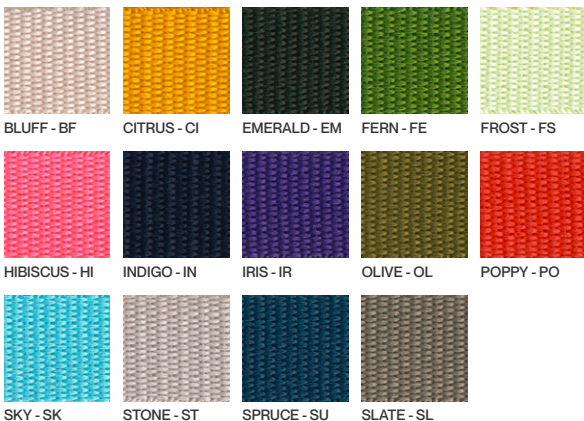

# DIMENSIONS

# QUD-L-DL

DATE	PROJECT	CATALOG #	FIXTURE TYPE
------	---------	-----------	--------------

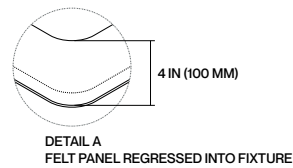
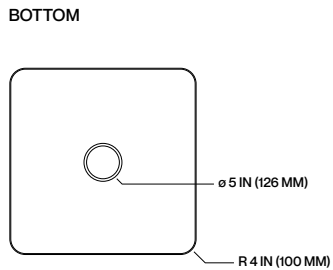
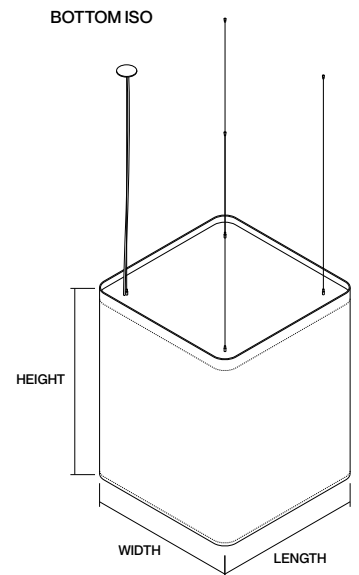
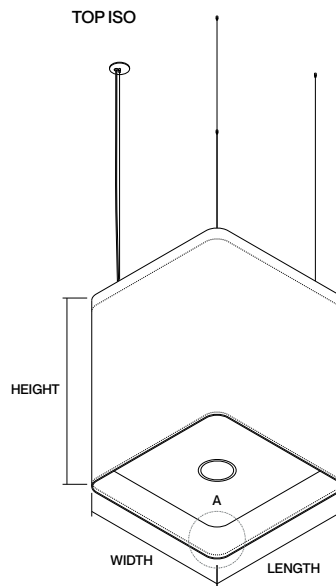
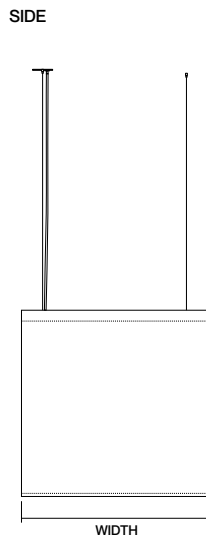
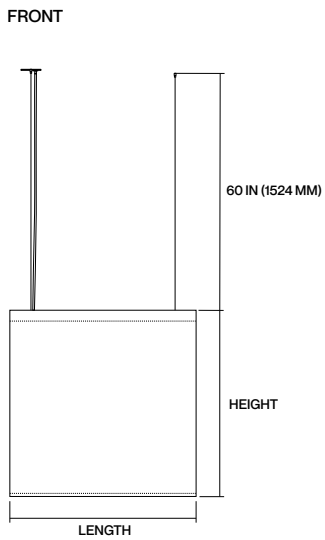
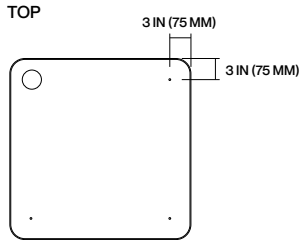

- 1 IMPERIAL DIMENSIONS ARE NOMINAL. ACTUAL DIMENSIONS ARE METRIC.
- 2 ALL STANDARD DIMENSIONS ARE ECO-CONSCIOUS, MAXIMIZING MATERIAL USE AND MINIMIZING WASTE. CUSTOM DIMENSIONS RESULT IN EXCESS MATERIAL WASTE.
- 3 PLEASE CONSULT THE FACTORY FOR WEIGHTS SPECIFIC TO CONFIGURATION.

# ACOUSTIC PERFORMANCE

# QUAD-L-DL

## TECHNICAL DATA

DATE	PROJECT	CATALOG #	FIXTURE TYPE
------	---------	-----------	--------------

## QUAD

ALL SABIN PRODUCTS ARE SUBJECT TO ACOUSTIC TESTING. PERFORMANCE VALUES WILL VARY BASED ON INSTALLATION FACTORS SUCH AS DENSITY AND MOUNTING HEIGHT.

**SABINS** A SABIN IS A UNIT OF SOUND ABSORPTION DEFINED AS THE AMOUNT OF SOUND ABSORBED BY ONE SQUARE FOOT OF A PERFECT ABSORBER. IT WAS INITIALLY CONCEIVED AS THE EQUIVALENT OF 1 SQUARE FOOT OF OPEN WINDOW, REFLECTING NO SOUND BACK INTO THE INTERIOR. SABINS ARE USED TO EXPRESS THE TOTAL EFFECTIVE ABSORPTION FOR THE INTERIOR OF A ROOM. THIS CHART INDICATES AVERAGE SABINS PER UNIT AT THE NOTED FREQUENCIES WHICH REPRESENT THE TYPICAL RANGE OF HUMAN SPEECH OF 200-2500 HZ.

**NRC** NOISE REDUCTION COEFFICIENT (NRC) IS A SINGLE NUMBER VALUE RANGING FROM 0.0 TO 1.0 THAT DESCRIBES THE AVERAGE SOUND ABSORPTION PERFORMANCE OF A MATERIAL. AN NRC OF 0.0 INDICATES THE OBJECT DOES NOT ABSORB MID-FREQUENCY SOUND ENERGY, BUT REFLECTS IT. AN NRC OF 1.0 INDICATES THAT THE SOUND ABSORPTION PERFORMANCE OF THE MATERIAL IS EQUAL TO ITS SURFACE AREA (MEASURED IN UNITS SABIN), OR CONCEPTUALLY 100% SOUND ABSORPTION.

PROJECTED NRC = .95

TOTAL SOUND ABSORPTION WILL VARY BASED ON DESIGNED PRODUCT CONFIGURATION. SABIN TESTS ALL PRODUCTS IN MULTIPLE CONFIGURATIONS. PLEASE CONTACT SABIN OR YOUR LOCAL AGENT FOR MORE INFORMATION.

**QUAD**  
ACOUSTIC PERFORMANCE

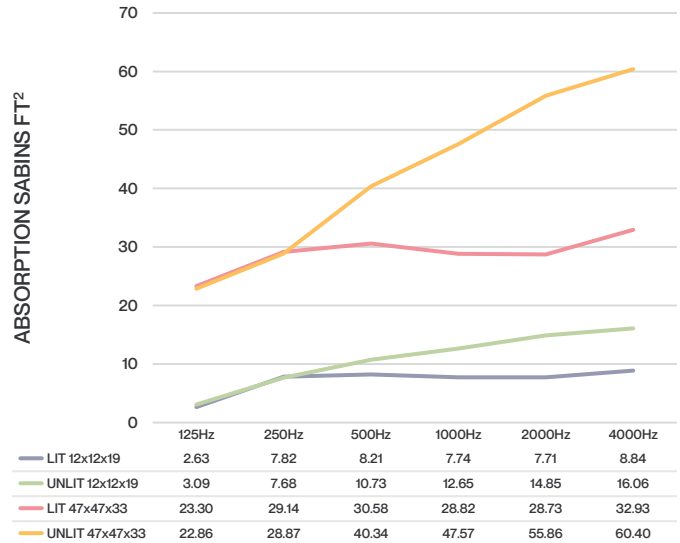

# LIGHTING PERFORMANCE

# QUD-L-DL

## TECHNICAL DATA

DATE	PROJECT	CATALOG #	FIXTURE TYPE
------	---------	-----------	--------------

## QUAD

### LIT - DOWNLIGHT

### PHOTOMETRIC PLOTS

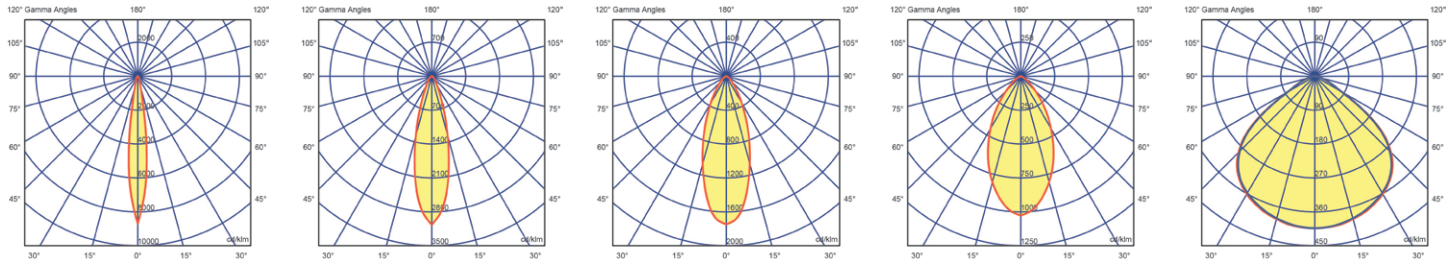

OPTIC	NARROW SPOT	OPTIC	SPOT	OPTIC	FLOOD	OPTIC	WIDE FLOOD	OPTIC	GENERAL AMBIENT
WATTAGE	24.0	WATTAGE	24.0	WATTAGE	24.0	WATTAGE	24.0	WATTAGE	24.0
LUMENS	2227.47	LUMENS	2159.5	LUMENS	2127.8	LUMENS	2102.8	LUMENS	2030.3

### DELIVERED LUMENS AND ENERGY USE

OPTIC	OUTPUT (LUMENS)	DELIVERED (LUMENS)	ENERGY (WATTS)	EFFICACY (LPW)
15° NARROW SPOT (DNS)	D750	718	9.5	75.5
	D1000	983	12.5	78.6
	D1500	1278	14.3	77.4
	D2000	2163	24.5	90.1
25° SPOT (DSP)	D750	696	9.5	73.2
	D1000	953	12.5	76.2
	D1500	1239	14.3	75.1
	D2000	2097	24.5	87.4
	D2500	2603	27.5	94.7
	D3000	3044	34.0	89.5
	D3500	3709	40.5	91.6
40° FLOOD (DFL)	D750	685	9.5	72.2
	D1000	939	12.5	75.1
	D1500	1221	14.3	74
	D2000	2066	24.5	86.1
	D2500	2545	27.5	92.5
60° WIDE FLOOD (DWF)	D3000	2976	34.0	87.5
	D3500	3627	40.5	89.5
	D750	677.5	9.5	71.3
	D1000	928	12.5	74.2
	D1500	1206	14.3	73.1
	D2000	2042	24.5	85.1
+90° GENERAL AMBIENT (DGA)	D2500	2453	27.5	89.2
	D3000	2868	34.0	84.4
	D3500	3495.5	40.5	86.3
	D750	654	9.5	68.9
	D1000	896	12.5	71.7
	D1500	1165	14.3	70.6
	D2000	1971	24.5	82.1

\*Based on 3000k, ≥90CRI. Lumen output and wattage may vary +/-5%.

### CCT MULTIPLIER

CCT	2700K	3000K	3500K	4000K
CRI	90	90	90	90
MULTIPLIER	0.93	1	1.05	1.07



© 2024 SABIN LLC. ALL RIGHTS RESERVED.  
 CUSTOMIZE AT SABIN.BUILD  
 DATE REVISED 09.30.2025



DATE	PROJECT	CATALOG #	FIXTURE TYPE
------	---------	-----------	--------------

## ACOUSTIC MATERIAL

Our PET (polyester) felt panels contain minimum 60% post-consumer recycled polyester staple fiber. It is moisture resistant, fire rated, recyclable, and an outstanding absorber of acoustic energy.

- Fire retardant: ASTM E84 Class A, EN13501 Class B
- Construction: 100% polyester fiber (PET)
- Material certifications: OEKO-TEX® Standard 100, SCS Recycled Content, and Declare

## CARE

Acoustic PET felt: Remove dust with compressed air, a vacuum or lint roller. Aluminum & polymer components: Remove dust and debris with a clean, dry, lint-free cloth.

## CERTIFICATES/LISTING

This product is ETL listed and tested to meet UL standards for lit configurations. It complies with NEC and ANSI/NFPA 70 requirements, is RoHS compliant, and rated IP20 for use in dry, indoor locations only. 90 CRI configurations also meet Title 24 JA8-2016 requirements. Additionally, this product is GREENGUARD Gold certified and holds Declare, OEKO-TEX® Standard 100, and SCS Recycled Content certifications.

## CONSTRUCTION

Acoustic luminaire comprised of ≥ 60% recycled PET material utilizing sewn construction to maximize strength, durability, and sound absorbency.

## DIMMING (LIT ONLY)

Standard 120-277V constant current driver includes 0-10V analog dimming to 1%. Options for Lutron EcoSystem at 120/277V, TRIAC/ELV DALI, DMX, and Warm Dim available on select products. Consult factory.

## ELECTRICAL (LIT ONLY)

High quality Class P isolated power supply with universal (120-277VAC) and 347V input voltage. Meets UL operation rating dry & damp (IP40) max 185°F (85°C) for 50,000 hour life. Luminaries are pre-wired with factory installed branch circuit wiring.

Power Factor:

- 0.95 @ 120VAC
- 0.90 @ 277VAC
- 0.90 @ 347VAC

For fixtures specified with an emergency battery/driver: 6W-20W integral battery (output dependent) with self-testing/metal test switch/indicator light (bi-color). Up to 15% of total lumen output for a minimum of 90 minutes. Listed to UL924 and tested to CSA 22.2 No.141 Field or Factory Installation (Indoor and Damp). Output Class 2 Compliant. Input CEC Title 20 Compliant.

## ESTIMATED LIFETIME (LIT ONLY)

L70 = >60,000 Hours. Luminous flux maintenance life L70(9k) based on IES TM-28-147 9000-hour test at Ta= 45°C.

CONSULT FACTORY FOR SPECIFIC PRODUCT CONFIGURATIONS.

# SABIN

© 2024 SABIN LLC. ALL RIGHTS RESERVED.  
 CUSTOMIZE AT SABIN.BUILD  
 DATE REVISED 09.30.2025

## LED LIGHT ENGINE (LIT ONLY)

Light module incorporates premium LEDs with heat sink to maximum lifetime. Available in 2700K, 3000K, 3500K or 4000K CCT with ≥90 CRI. Color accuracy = minimum 2.2x SDCM @ 3000K ±66K ΔLUV +0.0004 Standard deviation color matching (SDCM) based on ANSI standard C78.377A indicating the visible variance in correlated color temperature, also referred to as “MacAdam ellipse.”

## MOUNTING

Suspended by various methods including 1/16” aircraft cable, straps, grid clips or 3/8” threaded rod (adapters provided, threaded rod by others). Aircraft cable is available in precut lengths of 60” (1524 MM) or custom length from 24” (600 MM) to 120” (3048 MM). For lit units, fabric-covered power cord is provided along with a 5” (127 MM) feed canopy.

## OPTICS (LIT ONLY)

Injection molded, cut or extruded acrylic lens designed for efficient and homogeneous light distribution with superior color over angle performance. Beam control available on select configurations down to 15° and up to +90°. Optics are field changeable.

## WARRANTY

Fixture rated for operation in conditioned environments up to 77°F (25°C). Fixture is warranted to be free from defects and/or failure under normal use and proper storage for five (5) years from date of shipment.



**Declare.**

**PET Acoustic Felt**  
 Sabin LLC

Final Assembly: Chicago, Illinois, USA  
 Life Expectancy: 30 Year(s)  
 End of Life Options: Salvageable/Reusable in its Entirety, Recyclable (100%)

**Ingredients:**

Polyethylene Terephthalate: Polyethylene Terephthalate; Octadecanamide, N,N'-1,2-ethanediybis-: Octadecanamide, N,N'-1,2-ethanediybis-; **Stearic Acid:** Stearic Acid; **Benzenepropanoic acid, 3,5-bis(1,1-dimethylethyl)-4-hydroxy-, octadecyl ester:** Benzenepropanoic acid, 3,5-bis(1,1-dimethylethyl)-4-hydroxy-, octadecyl ester; **Benzenamine, 4-(1-methyl-1-phenylethyl)-N-[4-(1-methyl-1-phenylethyl)phenyl]-:** Benzenamine, 4-(1-methyl-1-phenylethyl)-N-[4-(1-methyl-1-phenylethyl)phenyl]; **Titanium dioxide:** Titanium dioxide

**Living Building Challenge Criteria:** Compliant

**I-13 Red List:**  
 LBC Red List Free % Disclosed: 100% at 100ppm  
 LBC Red List Approved VOC Content: Not Applicable  
 Declared

**I-10 Interior Performance:** Not Applicable  
**I-14 Responsible Sourcing:** Not Applicable

SAB-0001  
 EXP. 01 JUN 2025  
 Original Issue Date: 2023

MANUFACTURER RESPONSIBLE FOR LABEL ACCURACY  
 INTERNATIONAL LIVING FUTURE INSTITUTE™ [living-future.org/declare](http://living-future.org/declare)

