

QUAD

UNLIT

QUD-U

DATE	PROJECT	CATALOG #	FIXTURE TYPE
------	---------	-----------	--------------

OVERVIEW

Crafted with our signature sewn construction, QUAD is a design-forward acoustic pendant. With heights reaching up to 100 IN, options for light engines by others, and unlit configurations, QUAD seamlessly transforms into pendant, array, or cloud formations, making it ideal for high-performance lighting and acoustic systems.

QUICK FACTS

- Custom lengths between 16 - 47 IN and heights between 12 - 100 IN
- Suspension length between 24 - 120 IN
- Mount direct to strut, direct to grid, with threaded rod, straps, or by aircraft cable
- NRC rating of .95



SPECIFICATIONS

SERIES	LENGTH/WIDTH ¹	HEIGHT ¹	
QUD-U	16" X 16" (400 MM X 400 MM) 24" X 24" (600 MM X 600 MM) 35" X 35" (900MM X 900 MM) 47" X 47" (1200 MM X 1200 MM) CLW___ ²	12" (300 MM) 19" (475 MM) 24" (600 MM) 33" (850 MM) 53" (1350 MM) 100" (2550 MM) CH___ ³	
EXTERIOR FELT (1.5 MM)		INTERIOR FELT (1.5 MM)	
15___ REPLACE "___" WITH DESIRED COLOR CODE FROM SWATCHES		15___ REPLACE "___" WITH DESIRED COLOR CODE FROM SWATCHES	
SUSPENSION TYPE		CEILING TYPE	CANOPY ⁶
AC___ 60" AIRCRAFT CABLE + (COLOR CODE) ⁴ ST___ 60" STRAP + (COLOR CODE) ⁴ TRD 3/8" THREADED ROD DT DIRECT TO		HC HARD CEILING ⁵ ST STRUT SG STANDARD GRID TG TEGULAR GRID	NC NO CANOPIES RWH ROUND WHITE RBK ROUND BLACK SWH SQUARE WHITE SBK SQUARE BLACK
		PIPING	
		NP NO PIPING P___ REPLACE "___" WITH DESIRED COLOR CODE FROM SWATCHES	
		FACTORY OPTIONS ⁷	
		CSL___ CUSTOM SUSPENSION LENGTH 24" - 120" ⁸ CT___ CUSTOM THREAD + (COLOR CODE) ⁴ BABA BABA REQUIRED	

1 IMPERIAL DIMENSIONS ARE NOMINAL. ACTUAL DIMENSIONS ARE METRIC.
2 CUSTOM LENGTH/WIDTH AVAILABLE BETWEEN 12" - 47" (300 - 1200 MM).
3 CUSTOM HEIGHTS AVAILABLE BETWEEN 19" - 100" (475 - 2550 MM).
4 REPLACE "___" WITH DESIRED COLOR CODE FROM SWATCHES.

5 NOT AVAILABLE IN DIRECT TO SUSPENSION TYPE.
6 OPTIONAL 2IN CANOPIES CAN BE INCLUDED FOR CABLE, STRAP, OR GRID SUSPENSION.
7 LEAVE BLANK IF NOT APPLICABLE. STRING TOGETHER MULTIPLE SELECTIONS.
8 REPLACE "___" WITH LENGTH OF DESIRED SUSPENSION.

EXAMPLE CATALOG #: QUD-U-24(600)-24(600)-19(475)-15JD-15FL-NP-ACBLK-HC-NC

SABIN

© 2025 SABIN LLC. ALL RIGHTS RESERVED.
CUSTOMIZE AT SABIN.BUILD
DATE REVISED 09.17.2025



1

COLOR SWATCHES

QUD-U

DATE	PROJECT	CATALOG #	FIXTURE TYPE
------	---------	-----------	--------------

FELT



PIPING



SUSPENSION STRAP

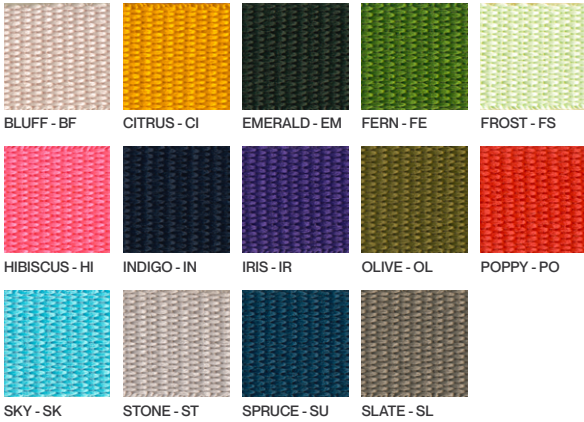

AIRCRAFT CABLE

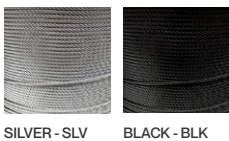

THREAD

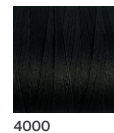

Colors are subject to slight variation from your screen or paper to the finished product. Contact the factory for additional color options.

¹ Birch is not available in 1.5 MM

DIMENSIONS

QUD-U

DATE	PROJECT	CATALOG #	FIXTURE TYPE
------	---------	-----------	--------------

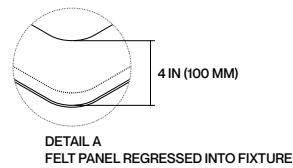
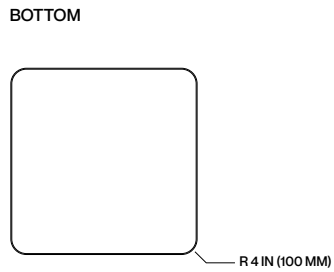
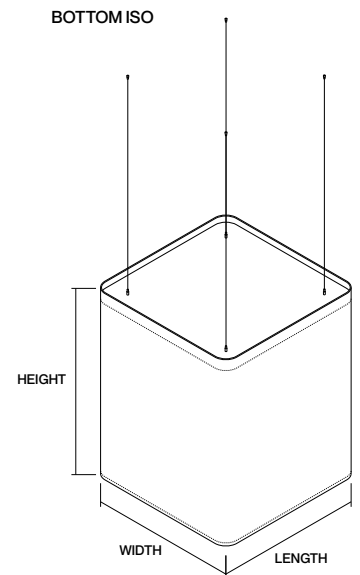
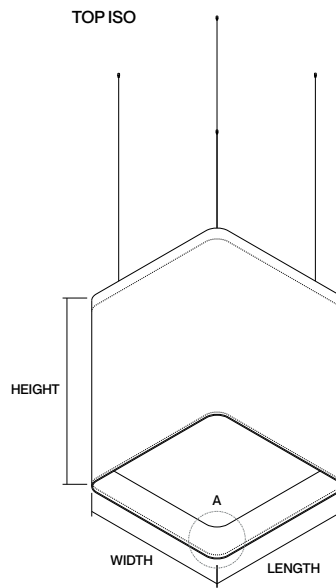
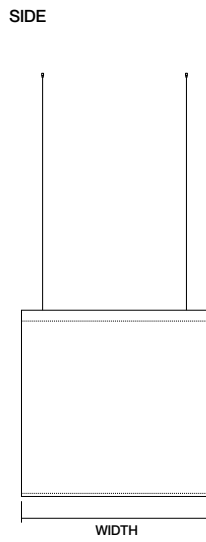
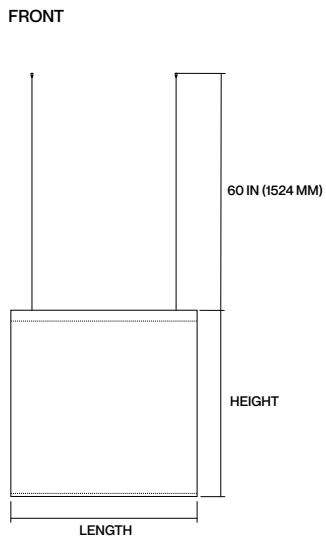
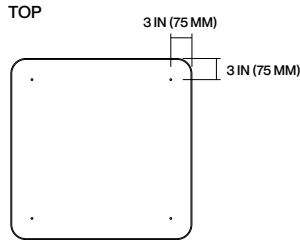

- 1 IMPERIAL DIMENSIONS ARE NOMINAL. ACTUAL DIMENSIONS ARE METRIC.
- 2 ALL STANDARD DIMENSIONS ARE ECO-CONSCIOUS, MAXIMIZING MATERIAL USE AND MINIMIZING WASTE. CUSTOM DIMENSIONS RESULT IN EXCESS MATERIAL WASTE.
- 3 PLEASE CONSULT THE FACTORY FOR WEIGHTS SPECIFIC TO CONFIGURATION.

ACOUSTIC PERFORMANCE

QUD-U

TECHNICAL DATA

DATE	PROJECT	CATALOG #	FIXTURE TYPE
------	---------	-----------	--------------

QUAD

ALL SABIN PRODUCTS ARE SUBJECT TO ACOUSTIC TESTING. PERFORMANCE VALUES WILL VARY BASED ON INSTALLATION FACTORS SUCH AS DENSITY AND MOUNTING HEIGHT.

SABINS A SABIN IS A UNIT OF SOUND ABSORPTION DEFINED AS THE AMOUNT OF SOUND ABSORBED BY ONE SQUARE FOOT OF A PERFECT ABSORBER. IT WAS INITIALLY CONCEIVED AS THE EQUIVALENT OF 1 SQUARE FOOT OF OPEN WINDOW, REFLECTING NO SOUND BACK INTO THE INTERIOR. SABINS ARE USED TO EXPRESS THE TOTAL EFFECTIVE ABSORPTION FOR THE INTERIOR OF A ROOM. THIS CHART INDICATES AVERAGE SABINS PER UNIT AT THE NOTED FREQUENCIES WHICH REPRESENT THE TYPICAL RANGE OF HUMAN SPEECH OF 200-2500 HZ.

NRC NOISE REDUCTION COEFFICIENT (NRC) IS A SINGLE NUMBER VALUE RANGING FROM 0.0 TO 1.0 THAT DESCRIBES THE AVERAGE SOUND ABSORPTION PERFORMANCE OF A MATERIAL. AN NRC OF 0.0 INDICATES THE OBJECT DOES NOT ABSORB MID-FREQUENCY SOUND ENERGY, BUT REFLECTS IT. AN NRC OF 1.0 INDICATES THAT THE SOUND ABSORPTION PERFORMANCE OF THE MATERIAL IS EQUAL TO ITS SURFACE AREA (MEASURED IN UNITS SABIN), OR CONCEPTUALLY 100% SOUND ABSORPTION.

PROJECTED NRC = .95

TOTAL SOUND ABSORPTION WILL VARY BASED ON DESIGNED PRODUCT CONFIGURATION. SABIN TESTS ALL PRODUCTS IN MULTIPLE CONFIGURATIONS. PLEASE CONTACT SABIN OR YOUR LOCAL AGENT FOR MORE INFORMATION.

QUAD
ACOUSTIC PERFORMANCE

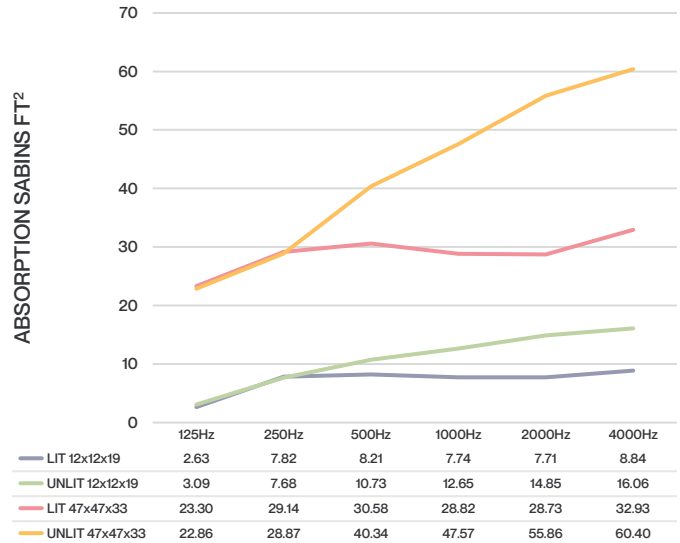

DATE	PROJECT	CATALOG #	FIXTURE TYPE

ACOUSTIC MATERIAL

Our PET (polyester) felt panels contain minimum 60% post-consumer recycled polyester staple fiber. It is moisture resistant, fire rated, recyclable, and an outstanding absorber of acoustic energy.

- Fire retardant: ASTM E84 Class A, EN13501 Class B
- Construction: 100% polyester fiber (PET)
- Material certifications: OEKO-TEX® Standard 100, SCS Recycled Content, and Declare

CARE

Acoustic PET felt: Remove dust with compressed air, a vacuum or lint roller. Aluminum & polymer components: Remove dust and debris with a clean, dry, lint-free cloth.

CERTIFICATES/LISTING

This product is ETL listed and tested to meet UL standards for lit configurations. It complies with NEC and ANSI/NFPA 70 requirements, is RoHS compliant, and rated IP20 for use in dry, indoor locations only. 90 CRI configurations also meet Title 24 JA8-2016 requirements. Additionally, this product is GREENGUARD Gold certified and holds Declare, OEKO-TEX® Standard 100, and SCS Recycled Content certifications.

CONSTRUCTION

Acoustic luminaire comprised of ≥ 60% recycled PET material utilizing sewn construction to maximize strength, durability, and sound absorbency.

MOUNTING

Suspended by various methods including 1/16" aircraft cable, straps, grid clips or 3/8" threaded rod (adapters provided, threaded rod by others). Aircraft cable is available in pre-cut lengths of 60" (1524 MM) or custom length from 24" (600 MM) to 120" (3048 MM). For lit units, fabric-covered power cord is provided along with a 5" (127 MM) feed canopy.

WARRANTY

Fixture rated for operation in conditioned environments up to 77°F (25°C). Fixture is warranted to be free from defects and/or failure under normal Use and proper storage for five (5) years from date of shipment.

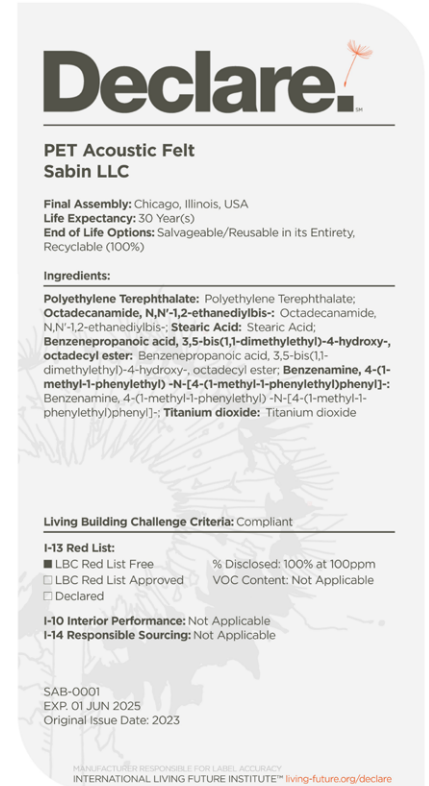

CONSULT FACTORY FOR SPECIFIC PRODUCT CONFIGURATIONS.