

# TRI

LIT - LIGHT BY OTHERS (LBO)<sup>™</sup>

# TRI-L-LBO

DATE	PROJECT	CATALOG #	FIXTURE TYPE
------	---------	-----------	--------------

## OVERVIEW

TRI is versatile and dynamic, featuring a unique triangular form with balanced rounded corners, ideal for lobbies, hallways, and transitional active spaces. It offers tailored solutions to exceed lighting and acoustic needs with customizable 1 IN increments between 24 - 47 IN in diameter and heights up to 100 IN. With Light by Others, TRI can be used with a variety of light engines chosen by the designer.

## QUICK FACTS

- Light by Others (LBO)<sup>™</sup> enables a customer to integrate their preferred light engine
- Aperture / cord / stem diameter up to 5 IN
- Custom diameters between 24 - 47 IN and heights between 12 - 100 IN
- Custom suspension length 24 - 120 IN
- NRC rating of .95

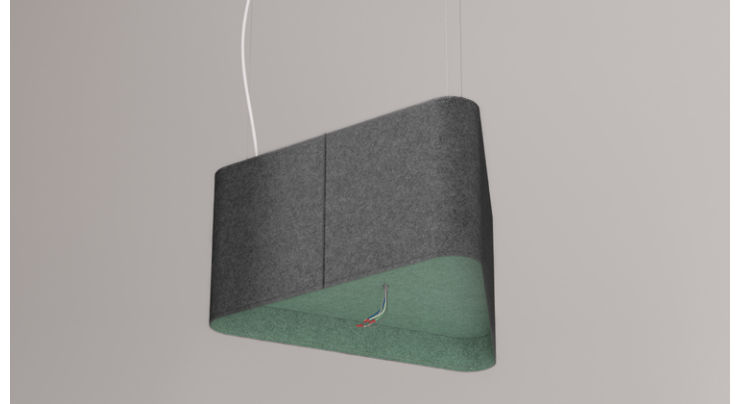

## SPECIFICATIONS

SERIES	TRI CIRCUMSCRIBED DIAMETER <sup>1,2,3</sup>	TRI HEIGHT <sup>1</sup>	APERTURE/CORD/STEM DIAMETER <sup>1,6</sup>	
TRI-L-LBO	24" (600 MM) 35" (900 MM) 47" (1200 MM) CD___ <sup>4</sup>	12" (300 MM) 19" (475 MM) 24" (600 MM) 33" (850 MM) 53" (1350 MM) 100" (2550 MM) CH___ <sup>5</sup>	3/8" (10 MM) 1/2" (13 MM) 3" (76 MM) 4" (102 MM) 5" (127 MM) CHD___ <sup>7</sup>	
EXTERIOR FELT (1.5 MM)		INTERIOR FELT (1.5 MM)		CORD COLOR <sup>8</sup>
15___ REPLACE "___" WITH DESIRED COLOR CODE FROM SWATCHES		15___ REPLACE "___" WITH DESIRED COLOR CODE FROM SWATCHES		PC___ REPLACE "___" WITH DESIRED COLOR CODE FROM SWATCHES
SUSPENSION TYPE		CEILING TYPE	CANOPY <sup>11</sup>	FACTORY OPTIONS <sup>12</sup>
AC___ 60" AIRCRAFT CABLE + (COLOR CODE) <sup>9</sup> ST___ 60" STRAP + (COLOR CODE) <sup>9</sup> TRD 3/8" THREADED ROD DT DIRECT TO		HC HARD CEILING <sup>10</sup> ST STRUT SG STANDARD GRID TG TEGULAR GRID	RWH ROUND WHITE RBK ROUND BLACK SWH SQUARE WHITE SBK SQUARE BLACK	CSL___ CUSTOM SUSPENSION LENGTH 24" - 120" <sup>13</sup> CT___ CUSTOM THREAD + (COLOR CODE) <sup>9</sup> 2CP INCLUDE 2" CANOPIES CF CENTER FEED BABA BABA REQUIRED

1 IMPERIAL DIMENSIONS ARE NOMINAL. ACTUAL DIMENSIONS ARE METRIC.  
 2 SEE DIMENSIONED DRAWINGS FOR ILLUSTRATION OF CIRCUMSCRIBED DIAMETER.  
 3 TRI DIAMETER MUST BE ≥ 12" (300 MM) LARGER THAN THE APERTURE/CORD/STEM DIAMETER.  
 4 CUSTOM DIAMETERS AVAILABLE BETWEEN 24" - 47" (600 - 1200 MM).  
 5 CUSTOM HEIGHTS AVAILABLE BETWEEN 12" - 100" (300 MM - 2550 MM).  
 6 DIAMETER OF THE HOLE TO ACCOMMODATE DOWNLIGHT/POWER CABLE/STEM.  
 7 MINIMUM 0.25" (6 MM) CUSTOM HOLE DIAMETER.

8 POWER CABLE IS 18" LONGER THAN SUSPENSION LENGTH. CONSULT FACTORY FOR LONGER LENGTHS.  
 9 REPLACE "\_\_\_" WITH DESIRED COLOR CODE FROM SWATCHES.  
 10 NOT AVAILABLE IN DIRECT TO SUSPENSION TYPE.  
 11 5" (127 MM) CANOPY PROVIDED FOR FEED. 2" (50.8 MM) CANOPIES FOR NON-FEED UPON REQUEST.  
 12 LEAVE BLANK IF NOT APPLICABLE. STRING TOGETHER MULTIPLE SELECTIONS.  
 13 REPLACE "\_\_\_" WITH LENGTH OF DESIRED SUSPENSION.

EXAMPLE CATALOG #: TPR-L-LBO-35(900)-24(600)-3/8(10)-15SI-15FL-NP-PCBR-ACBLK-HC-RWH-CF

**SABIN**

© 2025 SABIN LLC. ALL RIGHTS RESERVED.  
 CUSTOMIZE AT SABIN.BUILD  
 DATE REVISED 09.17.2025



1

# COLOR SWATCHES

# TRI-L-LBO

DATE	PROJECT	CATALOG #	FIXTURE TYPE
------	---------	-----------	--------------

## FELT



## PIPING



## POWER CORD



## AIRCRAFT CABLE



## THREAD



## SUSPENSION STRAP

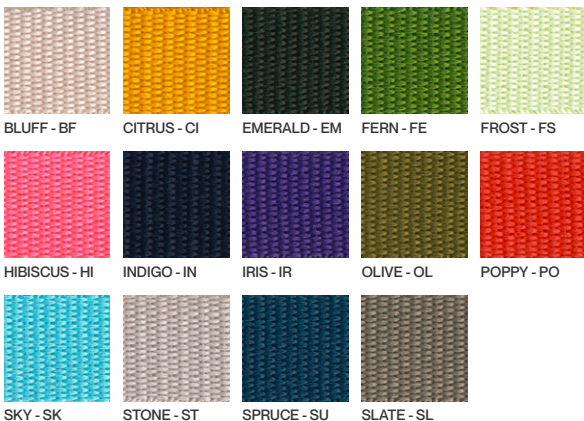

# DIMENSIONS

# TRI-L-LBO

DATE	PROJECT	CATALOG #	FIXTURE TYPE
------	---------	-----------	--------------

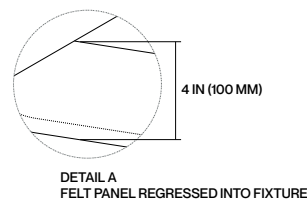
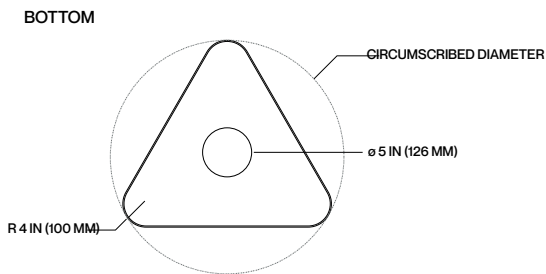
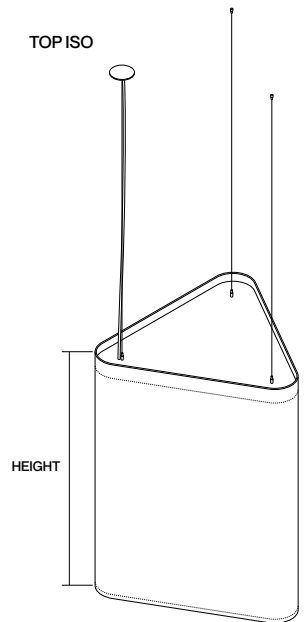
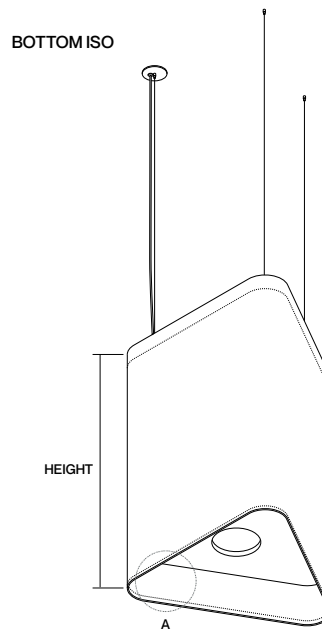
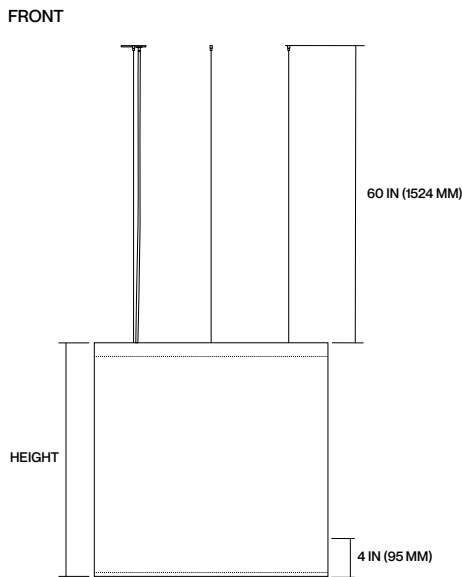
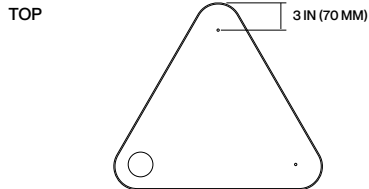

- 1 IMPERIAL DIMENSIONS ARE NOMINAL. ACTUAL DIMENSIONS ARE METRIC.
- 2 ALL STANDARD DIMENSIONS ARE ECO-CONSCIOUS, MAXIMIZING MATERIAL USE AND MINIMIZING WASTE. CUSTOM DIMENSIONS RESULT IN EXCESS MATERIAL WASTE.
- 3 PLEASE CONSULT THE FACTORY FOR WEIGHTS SPECIFIC TO CONFIGURATION.

# ACOUSTIC PERFORMANCE

# TRI-L-LBO

## TECHNICAL DATA

DATE	PROJECT	CATALOG #	FIXTURE TYPE
------	---------	-----------	--------------

## TRI

ALL SABIN PRODUCTS ARE SUBJECT TO ACOUSTIC TESTING. PERFORMANCE VALUES WILL VARY BASED ON INSTALLATION FACTORS SUCH AS DENSITY AND MOUNTING HEIGHT.

**SABINS** A SABIN IS A UNIT OF SOUND ABSORPTION DEFINED AS THE AMOUNT OF SOUND ABSORBED BY ONE SQUARE FOOT OF A PERFECT ABSORBER. IT WAS INITIALLY CONCEIVED AS THE EQUIVALENT OF 1 SQUARE FOOT OF OPEN WINDOW, REFLECTING NO SOUND BACK INTO THE INTERIOR. SABINS ARE USED TO EXPRESS THE TOTAL EFFECTIVE ABSORPTION FOR THE INTERIOR OF A ROOM. THIS CHART INDICATES AVERAGE SABINS PER UNIT AT THE NOTED FREQUENCIES WHICH REPRESENT THE TYPICAL RANGE OF HUMAN SPEECH OF 200-2500 HZ.

**NRC** NOISE REDUCTION COEFFICIENT (NRC) IS A SINGLE NUMBER VALUE RANGING FROM 0.0 TO 1.0 THAT DESCRIBES THE AVERAGE SOUND ABSORPTION PERFORMANCE OF A MATERIAL. AN NRC OF 0.0 INDICATES THE OBJECT DOES NOT ABSORB MID-FREQUENCY SOUND ENERGY, BUT REFLECTS IT. AN NRC OF 1.0 INDICATES THAT THE SOUND ABSORPTION PERFORMANCE OF THE MATERIAL IS EQUAL TO ITS SURFACE AREA (MEASURED IN UNITS SABIN), OR CONCEPTUALLY 100% SOUND ABSORPTION.

PROJECTED NRC = .95

TOTAL SOUND ABSORPTION WILL VARY BASED ON DESIGNED PRODUCT CONFIGURATION. SABIN TESTS ALL PRODUCTS IN MULTIPLE CONFIGURATIONS. PLEASE CONTACT SABIN OR YOUR LOCAL AGENT FOR MORE INFORMATION.

**TRI**  
ACOUSTIC PERFORMANCE

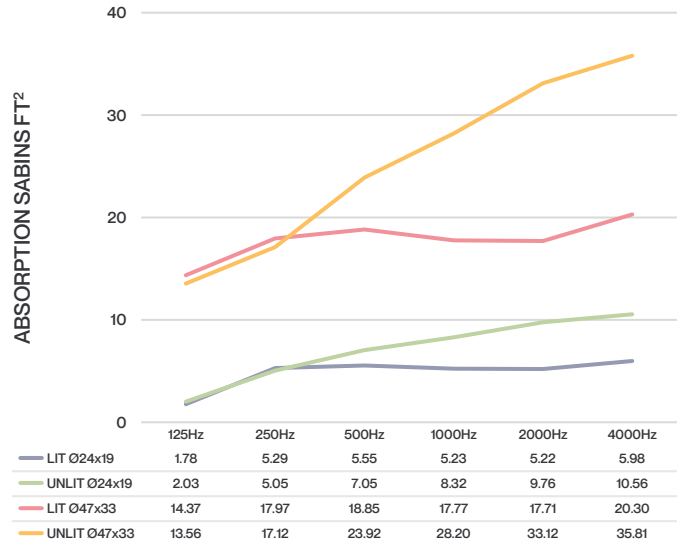

# NOTES

# TRI-L-LBO

DATE	PROJECT	CATALOG #	FIXTURE TYPE

## ACOUSTIC MATERIAL

Our PET (polyester) felt panels contain minimum 60% post-consumer recycled polyester staple fiber. It is moisture resistant, fire rated, recyclable, and an outstanding absorber of acoustic energy.

- Fire retardant: ASTM E84 Class A, EN13501 Class B
- Construction: 100% polyester fiber (PET)
- Material certifications: OEKO-TEX® Standard 100, SCS Recycled Content, and Declare

## CARE

Acoustic PET felt: Remove dust with compressed air, a vacuum or lint roller. Aluminum & polymer components: Remove dust and debris with a clean, dry, lint-free cloth.

## CERTIFICATES/LISTING

This product is ETL listed and tested to meet UL standards for lit configurations. It complies with NEC and ANSI/NFPA 70 requirements, is RoHS compliant, and rated IP20 for use in dry, indoor locations only. 90 CRI configurations also meet Title 24 JA8-2016 requirements. Additionally, this product is GREENGUARD Gold certified and holds Declare, OEKO-TEX® Standard 100, and SCS Recycled Content certifications.

## CONSTRUCTION

Acoustic luminaire comprised of ≥ 60% recycled PET material utilizing sewn construction to maximize strength, durability, and sound absorbency.

## MOUNTING

Suspended by various methods including 1/16" aircraft cable, straps, grid clips or 3/8" threaded rod (adapters provided, threaded rod by others). Aircraft cable is available in pre-cut lengths of 60" (1524 MM) or custom length from 24" (600 MM) to 120" (3048 MM). For lit units, fabric-covered power cord is provided along with a 5" (127 MM) feed canopy.

## WARRANTY

Fixture rated for operation in conditioned environments up to 77°F (25°C). Fixture is warranted to be free from defects and/or failure under normal Use and proper storage for five (5) years from date of shipment.

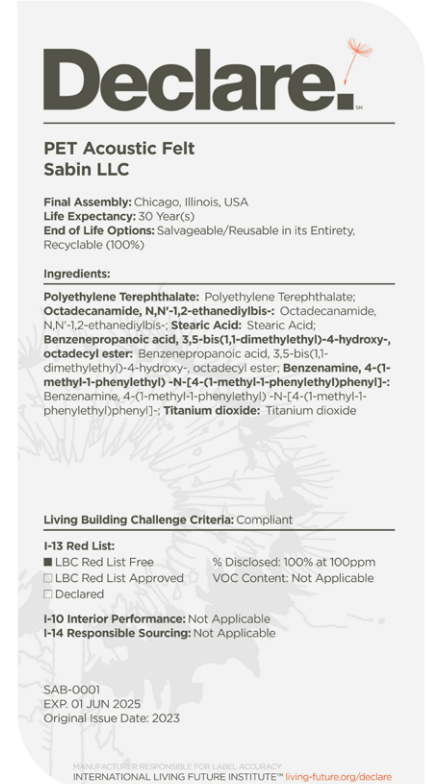

CONSULT FACTORY FOR SPECIFIC PRODUCT CONFIGURATIONS.

# SABIN

© 2024 SABIN LLC. ALL RIGHTS RESERVED.  
CUSTOMIZE AT SABIN.BUILD  
DATE REVISED 09.17.2025



# 5